



Katalog 01/2017

[www.baenfer.de](http://www.baenfer.de)

# Bänfer®

für KINDER



# Bänfer Qualität

Bänfer quality



HF Schweißarbeiten  
high frequency application



Schlosserei  
metalworking department



Zuschnittscutter  
computer controlled cutting



Kleberei  
adhesive department

Qualität und Sicherheit sind zwei Komponenten, die für uns ganz klar miteinander zu verknüpfen sind. Das ist nur, mit einem Fachkräfte-Team, wie wir es aufgestellt haben möglich - und darauf sind wir stolz. 50 Spezialisten mit einem enormen Fachwissen in den verschiedensten Bereichen arbeiten an Ihrer Bestellung und Ihrer Zufriedenheit. Stellen Sie uns doch mal auf Probe! Denn für uns zählen Sonderartikel zum Standard.

Quality and safety are two components, which we combine, of course. This is just with qualified employees possible. We have such a team and we are proud of it. 50 specialists are working on your order and for your contentment with a high knowledge in different departments. Test us! Special items are standard for us.



Näherei  
stitching



Polsterei  
upholstery department



Schreinerei  
carpentry



Verwaltung  
administration

Bezüglich unserer hohen Qualität und Verarbeitung unserer Produkte möchten wir ein paar wichtige Qualitätsmerkmale hervorheben:

- Speziell gefertigte Abdeckungen der Reißverschlüsse und der Schieber minimieren die Gefahr von Verletzungen.
- Die Entweichung der Luft ist durch Lüftungslöcher und den luftdurchlässigen Reißverschluss gegeben.
- Der Bezug besteht aus einem reißfesten Trägergewebe.
- Geruchsneutrale, leicht genarbte Bezüge gewährleisten griffiges und rutschfestes Spielen.
- Die Bezüge sind schwer entflammbar.
- Alle Schäume stimmen mit den europäischen Standards überein.

Regarding to high quality of production and workmanship of our products we would like to present some important characteristics:

- Specially covered zippers and zipper sliders decrease danger of injury.
- The task of ventilation holes and the breathable zipper is to leak out the air.
- The cover is made of tear-resistant support fabric.
- Odour-neutral, slightly grained coverings ensure handy and skid-proof playing.
- The cover material is heavily-inflammable.
- All foams are in accordance to European standards (FCKW-free).



Hochleistungsnaht  
heavy duty stitching



verdeckter, luftdurchlässiger Reißverschluss (nicht in der Außennaht)  
hidden, breathable zipper (of the outer stitching)

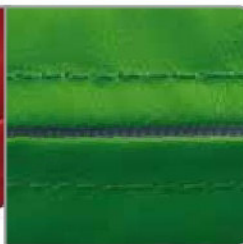

# Erklärungen

explanations

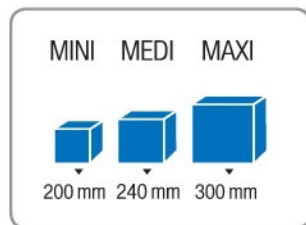

Die einzelnen Bausteingruppen und Module sind nach einem Größenschema entwickelt. Wir empfehlen Kombinationen mit gleichem Größenschema. Wir unterscheiden zwischen MINI, MEDI und MAXI. Das Größenschema MINI arbeitet mit einer Schenkellänge von 200 mm, MEDI mit 240 mm und MAXI mit 300 mm. Dabei empfehlen wir MINI für 0- bis 2-Jährige, MEDI für 2- bis 4-Jährige und MAXI ab 4 aufwärts.

The single sets or modules are under a size schematic developed. We recommend combinations with the same size schematic. We differentiate between MINI, MEDI and MAXI. The size schematic MINI has a 200 mm grid, MEDI a 240 mm grid and MAXI a 300 mm grid. We recommend MINI for children between 0 and 2 years, MEDI for children between 2 and 4 years and MAXI for children who are 4 years and older.



PU-Schaum und Verbundschaum: Öko-Tex zertifiziert  
PU foam and composite foam: Oeko-Tex standard certified



Turnmattenstoff, Planenstoff und Leichtplanenstoff: phthalatfrei, Schweißechtheit, Speicherechtheit, Urinbeständigkeit, Lichtehtheit = 7-8 (hervorragend)

textured tarpaulin, tarpaulin and light tarpaulin: phthalates-free, perspiration resistance, salivary resistance, urine resistance, UV resistance = 7-8 (superb)



Turnmattenstoff und Planenstoff: Brennverhalten < 100 mm/min nach ISO 3795 1989 (schwer entflammbar), Leichtplanenstoff: Brennverhalten M2 (schwer entflammbar)

textured tarpaulin and tarpaulin: flammability < 100 mm/min in accordance with ISO 3795 1989 (hardly inflammable), light tarpaulin: flammability M2 (hardly inflammable)



MagCon ist die neue patentierte Verbindung von Bausteinen mit Magnetstreifen. Die eingebauten Magnete (unter dem orangefarbenen Planenstoff) bieten zusätzliche Funktionen, wie das Kombinieren und Verbinden einzelner Bausteine. Weiterhin entfällt die lästige Verschmutzung, welche bei Klettecken ab einer gewissen Zeit üblich ist. Dabei gehen keine Funktionen der einzelnen Bausteine verloren, da die Magnete optimal unter dem Planenstoff verschwinden und keine gefährlichen Ecken und Kanten entstehen.

MagCon is the new patented connection of bricks with magnetic strips. The built-in magnets (under the orange coloured canvas) have more functions like to combine single bricks. Another advantage that there is no dirtying of the usual Velcro what is common after a certain time of use. The single bricks do not lose a function. In addition, the magnets are hidden under the sleeve and there are no hazardous corners or edges.

# Kataloginhalt

catalogue content



## 7 Bausteinsätze

- |   |                                      |
|---|--------------------------------------|
| 8 Bausteinsätze MINI                    | module sets MINI                     |
| 10 Bausteinsätze MEDI                   | module sets MEDI                     |
| 12 Bausteinsätze MAXI                   | module sets MAXI                     |
| 16 Weichböden mit Bausteinkern          | gymnastic mats with module sets      |
| 18 Neuigkeiten: Kunstlederbausteinsätze | news: artificial leather module sets |



## 21 Baumodule

- |                                      |                              |
|--------------------------------------|------------------------------|
| 22 Baumodule MEDI                    | element sets MEDI            |
| 26 Baumodule MAXI                    | element sets MAXI            |
| 32 Baumodule Einzelteile             | single components            |
| 40 Bewegungsbaustelle - Konzept BeMo | movement site - concept BeMo |



## 46 Kreativ-Spiel

- |                          |                         |
|--------------------------|-------------------------|
| 47 Ballbäder             | ball pools              |
| 51 Puzzle- & Aktivspiele | puzzle and active games |
| 58 Schaukeln             | swings                  |
| 60 Spielmatten           | playing mats            |



## 62 Turnen, Fall- & Prallschutz

- |                                 |                             |
|---------------------------------|-----------------------------|
| 63 Turnmatten                   | gym mats                    |
| 70 Weichböden                   | safety mats                 |
| 72 Fallschutzmatten und Systeme | protection mats and systems |
| 80 Schutzpolster                | protection pads             |
| 84 Timeout-Räume                | time out rooms              |
| 85 Shoezelenräume               | Snoezelen rooms             |
| 86 Wandmatten                   | wall mats                   |



## 87 Möbel

- |                        |                      |
|------------------------|----------------------|
| 90 Sessel & Sofas      | chairs and sofas     |
| 99 Matten & Polster    | mats and cushions    |
| 103 Wickelaufgabe      | changing mat         |
| 104 Kissen & Sitzsäcke | pillows and beanbags |

## 106 Stichwortverzeichnis

index



Informationen und Beispiele zu unserer Projektarbeit finden Sie auf den Seiten 45, 77-79, 83-85.

You can find information and examples of our projects on pages 45, 77-79, 83-85.

# Bausteinsätze

module sets



- |   |                                      |
|---|--------------------------------------|
| 8 Bausteinsätze MINI                    | module sets MINI                     |
| 10 Bausteinsätze MEDI                   | module sets MEDI                     |
| 12 Bausteinsätze MAXI                   | module sets MAXI                     |
| 16 Weichböden mit Bausteinkern          | gymnastic mats with module sets      |
| 18 Neuigkeiten: Kunstlederbausteinsätze | news: artificial leather module sets |

Anregend und zugleich aufregend sind die Spiel- und Gestaltungsmöglichkeiten mit diesen Bausteinsätzen. So lassen sich kleine und große Abenteuer bestreiten. Lassen Sie der Kreativität der Kinder freien Lauf und erleben Sie selbst was in den Kleinen steckt. Durch häufigen Einsatz der Bausteine fördern Sie Kreativität und Motorik.

Leichtplanenstoff: schwer entflammbar, phthalatfrei, urin- und schweißbeständig, speichelecht  
 Schaum: Öko-TEX zertifiziert

Stimulating and exciting are the play and composition possibilities with these module-sets. Children like to go on adventures with them. Give free reign to children's fantasy. Due to frequently use, creativity and motor function are encourage.

light tarpaulin: low flammability, phthalates-free, urine and sweat resistant, salivary resistant  
 foam: Oeko-TEX standard certified



Leichtplanenstoff  
light tarpaulin

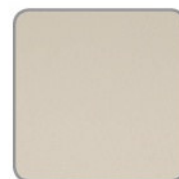

Kunstleder  
artificial leather



flammhemmend  
flame-retarding



flüssigkeitsbeständig  
fluid resistant

## 6-teiliger Bausteinsatz MINI

6 pcs. module set MINI

Art. 95-410-16

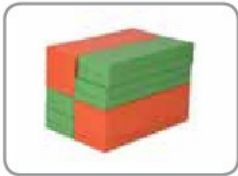

Block (verpackt)	block (packed)
4 Quader	4 cuboids
2 Quader	2 cuboids



600 x 400 x 400 mm
600 x 200 x 100 mm
600 x 200 x 200 mm

## 12-teiliger Bausteinsatz MINI

12 pcs. module set MINI

Art. 95-800-16



Block (verpackt)	block (packed)
4 Würfel	4 cubes
1 Quader	1 cuboid
2 Quader	2 cuboids
1 Brücke	1 bridge
1 halber Zylinder	1 half cylinder
2 Dreiecke	2 triangles
1 Dreieck	1 triangle



800 x 600 x 200 mm
200 x 200 x 200 mm
400 x 200 x 200 mm
400 x 200 x 100 mm
400 x 200 x 200 mm
200 x Ø 300 mm
200 x 200 x 200 mm
400 x 200 x 200 mm

## 14-teiliger Bausteinsatz MINI

14 pcs. module set MINI

Art. 95-430-16

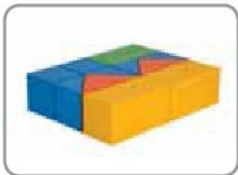

Block (verpackt)	block (packed)
2 Brücken	2 bridges
2 halbe Zylinder	2 half cylinders
2 Quader	2 cuboids
2 Würfel	2 cubes
4 Dreiecke	4 triangles
2 Dreiecke	2 triangles



800 x 600 x 200 mm
400 x 200 x 200 mm
200 x Ø 200 mm
400 x 200 x 100 mm
200 x 200 x 200 mm
200 x 200 x 200 mm
400 x 200 x 200 mm

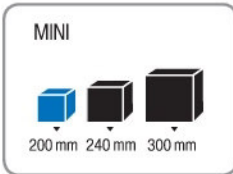

Alle Einzelteile dieser Seite sind nach dem Größenschema MINI entwickelt.  
Wir empfehlen Kombinationen mit gleichem Größenschema.

All items of the page are under the size schematic MINI developed.  
We recommend combinations with the same size schematic.



## 16-teiliger Bausteinsatz MINI

16 pcs. module set MINI

Art. 95-810-16

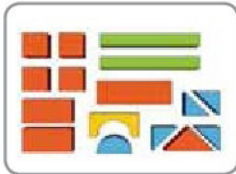

Block (verpackt)	block (packed)		
4 Würfel	4 cubes		1000 x 800 x 200 mm
2 Quader	2 cuboids		200 x 200 x 200 mm
2 Quader	2 cuboids		400 x 200 x 200 mm
1 Quader	1 cuboid		800 x 200 x 100 mm
1 Brücke	1 bridge		600 x 200 x 200 mm
1 halber Zylinder	1 half cylinder		400 x 200 x 200 mm
4 Dreiecke	4 triangles		200 x Ø 300 mm
1 Dreieck	1 triangle		200 x 200 x 200 mm
			400 x 200 x 200 mm

## 28-teiliger Bausteinsatz MINI

28 pcs. module set MINI

Art. 95-400-16

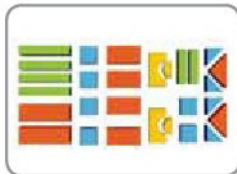

Block (verpackt)	block (packed)		
2 Dreiecke	2 triangles		800 x 600 x 600 mm
4 Dreiecke	4 triangles		400 x 200 x 200 mm
2 Würfel	2 cubes		200 x 200 x 200 mm
2 Quader	2 cuboids		200 x 200 x 200 mm
2 Brücken	2 bridges		400 x 200 x 100 mm
2 halbe Zylinder	2 half cylinders		400 x 200 x 200 mm
4 Quader	4 cuboids		200 x Ø 200 mm
4 Würfel	4 cubes		400 x 200 x 200 mm
2 Quader	2 cuboids		200 x 200 x 200 mm
4 Quader	4 cuboids		600 x 200 x 200 mm
			600 x 200 x 100 mm



## 6-teiliger Bausteinsatz MEDI

6 pcs. module set MEDI

Art. 95-532-16



Block (verpackt)	block (packed)	
2 Zylinder	2 cylinders	
2 Zylinder	2 cylinders	
2 Zylinder	2 cylinders	

	720 x 480 x 480 mm
	240 x Ø 240 mm
	480 x Ø 240 mm
	720 x Ø 240 mm



## 8-teiliger Bausteinsatz MEDI

8 pcs. module set MEDI

Art. 95-531-16



Block (verpackt)	block (packed)	
4 Würfel	4 cubes	
2 Quader	2 cuboids	
2 Quader	2 cuboids	

	960 x 480 x 480 mm
	240 x 240 x 240 mm
	480 x 240 x 240 mm
	960 x 240 x 240 mm

## 14-teiliger Bausteinsatz MEDI

14 pcs. module set MEDI

Art. 95-523-16



Block (verpackt)	block (packed)	
4 Dreiecke	4 triangles	
2 halbe Zylinder	2 half cylinders	
2 Zylinder	2 cylinders	
2 Wellen	2 waves	
1 Quader	1 cuboid	
1 Quader	1 cuboid	
2 Brücken	2 bridges	

	720 x 480 x 480 mm
	240 x 240 x 240 mm
	240 x Ø 240 mm
	480 x Ø 120 mm
	480 x 240 x 180 mm
	480 x 240 x 120 mm
	480 x 240 x 240 mm
	480 x 240 x 240 mm



## 18-teiliger Bausteinsatz MEDI

18 pcs. module set MEDI

Art. 95-522-16



Block (verpackt)	block (packed)		
2 Quader	2 cuboids		720 x 480 x 720 mm
1 Quader	1 cuboid		480 x 240 x 120 mm
3 Würfel	3 cubes		480 x 240 x 240 mm
2 Dächer	2 roofs		240 x 240 x 240 mm
4 Dreiecke	4 triangles		240 x 480 x 480 mm
1 halber Zylinder	1 half cylinder		240 x 240 x 240 mm
2 halbe Zylinder	2 halfcylinders		480 x Ø 240 mm
1 Zylinder	1 cylinder		240 x Ø 240 mm
2 Zylinder	2 cylinders		480 x Ø 240 mm
			240 x Ø 240 mm

## 20-teiliger Bausteinsatz MEDI auf Rollwagen, inkl. Bezug

20 pcs. module set MEDI on trolley, incl. cover

Art. 95-500-16

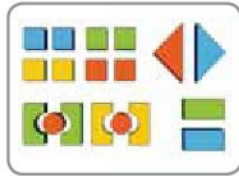

Block (verpackt)	block (packed)		
8 Würfel	8 cubes		1440 x 480 x 480 mm
2 Quader	2 cuboids		240 x 240 x 240 mm
4 Brücken	4 bridges		480 x 240 x 240 mm
2 Zylinder	2 cylinders		480 x 240 x 240 mm
2 Dreiecke	2 triangles		240 x Ø 240 mm
1 Überzug	1 cover		240 x 480 x 480 mm
1 Rollwagen	1 trolley		1440 x 480 x 480 mm

## 20-teiliger Bausteinsatz MEDI

20 pcs. module set MEDI

Art. 95-530-16

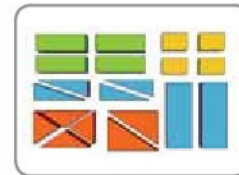
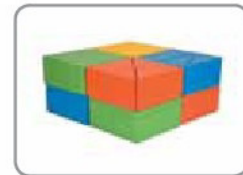

Art. 95-530B-WB (Planenstoff, blau (tarpaulin, blue)),  
Weichbodenbezug für den 20-teiligen Bausteinsatz  
landing mat cover for the 20 pcs. module set



Block (verpackt)	block (packed)		
4 Quader	4 cuboids		1680 x 960 x 240 mm
4 Würfel	4 cubes		480 x 240 x 240 mm
2 Quader	2 cuboids		240 x 240 x 240 mm
4 Keile	4 wedges		960 x 240 x 240 mm
4 Dreiecke	4 triangles		240 x 480 x 240 mm
2 Dreiecke	2 triangles		240 x 340 x 340 mm
			240 x 480 x 480 mm

## 5-teiliger Bausteinsatz MAXI

5 pcs. module set MAXI

Art. 95-557-16

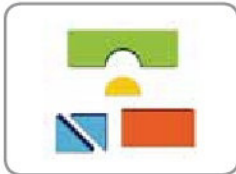
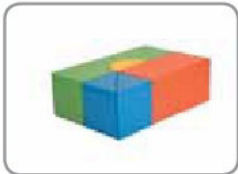

Block (verpackt)	block (packed)		900 x 600 x 300 mm
1 Brücke	1 bridge		900 x 300 x 300 mm
1 halber Zylinder	1 half cylinder		300 x Ø 300 mm
2 Dreiecke	2 triangles		300 x 300 x 300 mm
1 Quader	1 cuboid		600 x 300 x 300 mm

## 6-teiliger Bausteinsatz MAXI

6 pcs. module set MAXI

Art. 95-120-16

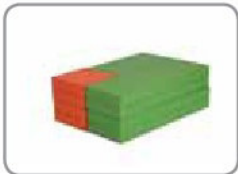



Block (verpackt)	block (packed)		900 x 600 x 300 mm
2 Quader	2 cuboids		900 x 300 x 150 mm
2 Quader	2 cuboids		600 x 300 x 150 mm
2 Quader	2 Quader		300 x 300 x 150 mm

## 7-teiliger Bausteinsatz MAXI

7 pcs. module set MAXI

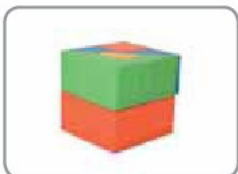
Art. 71-190-16



Block (verpackt)	block (packed)		600 x 600 x 600 mm
2 Quader	2 cuboids		600 x 300 x 300 mm
1 Würfel	1 cube		300 x 300 x 300 mm
2 Dreiecke	2 triangles		300 x 300 x 300 mm
1 halber Zylinder	1 half cylinder		300 x Ø 300 mm
1 Dach	1 roof		600 x 600 x 300 mm

## 12-teiliger Bausteinsatz MAXI

12 pcs. module set MAXI

Art. 95-540-16

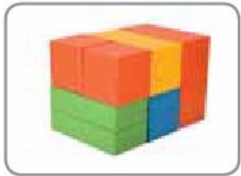

Block (verpackt)	block (packed)		1200 x 900 x 300 mm
2 Quader	2 cuboids		600 x 300 x 150 mm
1 Brücke	1 bridge		600 x 300 x 300 mm
1 halber Zylinder	1 half cylinder		300 x Ø 300 mm
2 Dreiecke	2 triangles		300 x 300 x 300 mm
1 Dreieck	1 triangle		600 x 300 x 300 mm
4 Würfel	4 cubes		300 x 300 x 300 mm
1 Quader	1 cuboid		600 x 300 x 300 mm

## 13-teiliger Bausteinsatz MAXI

13 pcs. module set MAXI

Art. TR-945630-16



Dieser Bausteinsatz hat auch flammhemmende Schaumstoffkerne.  
This module set has flame-resistant foam cores.

4 Dreiecke	4 triangles		300 x 300 x 300 mm
2 Würfel	2 cubes		300 x 300 x 300 mm
2 Quader	2 cuboids		300 x 300 x 600 mm
1 Matte	1 mat		450 x 1000 x 70 mm
2 Brücken	2 bridges		900 x 300 x 300 mm
2 Quader	2 cuboids		300 x 300 x 150 mm

## 14-teiliger Bausteinsatz MAXI

14 pcs. module set MAXI

Art. 71-220-16

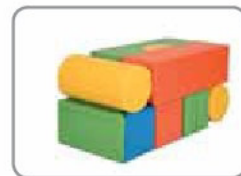

Block (verpackt)	block (packed)		1200 x 600 x 600 mm
1 Quader	1 cuboid		600 x 300 x 300 mm
2 Würfel	2 cubes		300 x 300 x 300 mm
2 halbe Zylinder	2 half cylinders		600 x Ø 300 mm
2 halbe Zylinder	2 half cylinders		300 x Ø 300 mm
1 Zylinder	1 cylinder		600 x Ø 300 mm
1 Brücke	1 bridge		900 x 300 x 300 mm
1 Dach	1 roof		600 x 600 x 300 mm
2 Dreiecke	2 triangles		300 x 300 x 300 mm
2 Quader	2 cuboids		600 x 300 x 150 mm

## 17-teiliger Bausteinsatz MAXI

17 pcs. module set MAXI

Art. 95-553-16



Block (verpackt)	block (packed)		
2 halbe Zylinder	2 half cylinders		900 x 900 x 750 mm
1 halber Zylinder	1 half cylinder		300 x Ø 300 mm
3 Zylinder	3 cylinders		600 x Ø 300 mm
2 Würfel	2 cubes		600 x Ø 300 mm
2 Quader	2 cuboids		300 x 300 x 300 mm
3 Quader	3 cuboids		600 x 300 x 300 mm
2 Dreiecke	2 triangles		600 x 300 x 150 mm
2 Dächer	2 roofs		300 x 300 x 300 mm
			600 x 600 x 300 mm

## 18-teiliger Bausteinsatz MAXI

18 pcs. module set MAXI

Art. TR-945600-16



Dieser Bausteinsatz hat auch flammhemmende Schaumstoffkerne.  
This module set has flame-resistant foam cores.

1 Dreieck	1 triangle		900 x 300 x 300 mm
4 Dreiecke	4 triangles		300 x 300 x 300 mm
2 Quader	2 cuboids		600 x 300 x 300 mm
2 Würfel	2 cubes		300 x 300 x 300 mm
2 L-Elemente	2 L-elements		600 x 600 x 300 mm
2 Brücken	2 bridges		900 x 300 x 300 mm
2 Quader	2 cuboids		300 x 300 x 150 mm
2 Zylinder	2 cylinders		300 x Ø 300 mm
1 Matte	1 mat		1500 x 100 x 60 mm

## 18-teiliger Bausteinsatz MAXI

18 pcs. module set MAXI

Art. 95-110-16

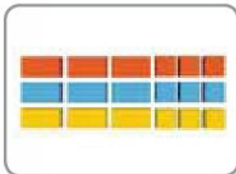

Block (verpackt)	block (packed)		
3 Quader	3 cuboids		900 x 900 x 900 mm
3 Quader	3 cuboids		600 x 300 x 300 mm
3 Quader	3 cuboids		600 x 300 x 300 mm
3 Quader	3 cuboids		600 x 300 x 300 mm
3 Würfel	3 cubes		300 x 300 x 300 mm
3 Würfel	3 cubes		300 x 300 x 300 mm
3 Würfel	3 cubes		300 x 300 x 300 mm

## 19-teiliger Bausteinsatz MAXI

19 pcs. module set MAXI

Art. 95-100-16



Block (verpackt)	block (packed)
2 Quader	2 cuboids
2 Würfel	2 cubes
2 Quader	2 cuboids
2 Brücken	2 bridges
2 Dreiecke	2 triangles
2 Dreiecke	2 triangles
1 Dreieck	1 triangle
2 Zylinder	2 cylinders
2 L-Elemente	2 L-elements
2 Dreiecke	2 triangles

	900 x 900 x 900 mm
	600 x 300 x 300 mm
	300 x 300 x 300 mm
	300 x 300 x 150 mm
	900 x 300 x 300 mm
	300 x 300 x 300 mm
	300 x 300 x 600 mm
	600 x 600 x 300 mm
	300 x Ø 300 mm
	600 x 600 x 300 mm
	425 x 425 x 300 mm

## 21-teiliger Bausteinsatz MAXI

21 pcs. module set MAXI

Art. 71-210-16



Block (verpackt)	block (packed)
2 Brücken	2 bridges
2 Quader	2 cuboids
2 Quader	2 cuboids
1 Zylinder	1 cylinder
2 halbe Zylinder	2 half cylinders
4 halbe Zylinder	4 half cylinders
2 Dreiecke	2 triangles
1 Dreieck	1 triangle
2 Würfel	2 cubes
1 Dach	1 roof
2 halbe Dächer	2 half roofs

	1200 x 900 x 600 mm
	900 x 300 x 300 mm
	600 x 300 x 300 mm
	600 x 300 x 150 mm
	600 x Ø 300 mm
	600 x Ø 300 mm
	300 x Ø 300 mm
	300 x 300 x 300 mm
	300 x 300 x 600 mm
	300 x 300 x 300 mm
	600 x 600 x 300 mm
	600 x 300 x 300 mm

## 23-teiliger Bausteinsatz MAXI

23 pcs. module set MAXI

Art. 95-542-16



Block (verpackt)	block (packed)
3 Würfel	3 cubes
3 Quader	3 cuboids
2 Quader	2 cuboids
3 Quader	3 cuboids
2 Quader	2 cuboids
2 Brücken	2 bridges
2 halbe Zylinder	2 half cylinders
4 Dreiecke	4 triangles
2 Dreiecke	2 triangles

	1200 x 1200 x 600 mm
	300 x 300 x 300 mm
	600 x 300 x 300 mm
	1200 x 300 x 150 mm
	900 x 300 x 300 mm
	600 x 300 x 150 mm
	600 x 300 x 300 mm
	300 x Ø 300 mm
	300 x 300 x 300 mm
	425 x 425 x 300 mm

## Weichböden mit Bausteinkern

landing mat with single modules inside



Diese Bausteinsätze können Sie einfach in einem Weichbodenbezug verstauen.  
So haben Sie gleichzeitig einen Weichboden als Fallschutz.  
Unterseite der Weichböden: rutschfester Tummattenstoff

These sets can be stowed away in a landing mat cover. So you have a landing mat out of the module.  
Bottom of the landing mat: anti-slip tarpaulin

## 12-teiliger Bausteinsatz MAXI

12 pcs. module set MAXI



Bausteinsatz, 12-teilig  
module set, 12 pcs.  
Weichbodenbezug  
landing mat cover  
SET

1500 x 900 x 300 mm

Art. 34-1020-16

Art. 34-1020B-1

Art. 34-1023-1-16

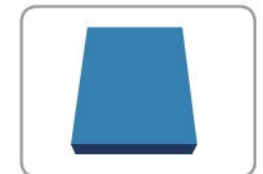
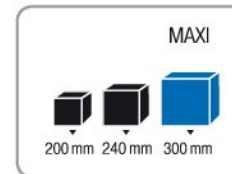

## 21-teiliger Bausteinsatz MAXI

21 pcs. module set MAXI



Bausteinsatz, 21-teilig  
module set, 21 pcs.  
Weichbodenbezug  
landing mat cover  
SET

1500 x 1500 x 300 mm

Art. 34-1021-16

Art. 34-1026B-WB

Art. 34-1021-1-16

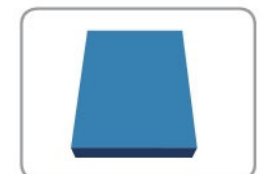
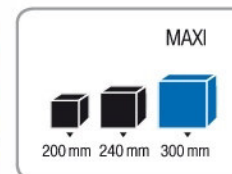

## 24-teiliger Bausteinsatz MAXI im Bezug

24 pcs. module set MAXI incl. cover



Abb. ähnlich, image similar

Dieses Set besteht aus zwei 12-teiligen Bausteinsätzen MAXI (34-1020-16) und einem Bezug.  
This set consists of two 12 pcs. module sets MAXI (34-1020-16) and a cover.

SET

1800 x 1500 x 300 mm

Art. 34-1023-16

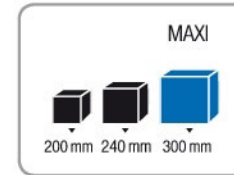

## 33-teiliger Bausteinsatz MAXI im Bezug

33 pcs. module set MAXI incl. cover



Dieses Set besteht aus einem 12-teiligen Bausteinsatz MAXI (34-1020-16), einem 21-teiligen Bausteinsatz MAXI (34-1021-16) und einem Bezug.  
This set consists of a 12 pcs. module set MAXI (34-1020-16), a 21 pcs. module set MAXI (34-1021-16) and a cover.

SET

2400 x 1500 x 300 mm

Art. 34-1024-16

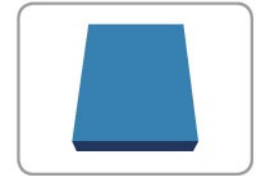
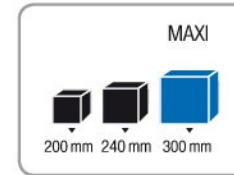

## 42-teiliger Bausteinsatz MAXI im Bezug

42 pcs. module set MAXI incl. cover



Dieses Set besteht aus zwei 21-teiligen Bausteinsätzen MAXI (34-1021-16) und einem Bezug.  
This set consists of two 21 pcs. module sets MAXI (34-1021-16) and a cover.

SET

3000 x 1500 x 300 mm

Art. 34-1022-16

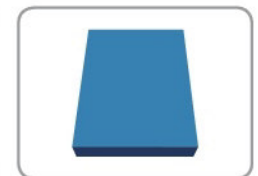
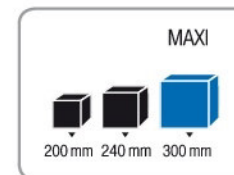

# Neuigkeiten

news

Diese vielseitigen Bausteine werden zum Ganzjahres-Highlight im Kinderzimmer. Sie sind ideal zum Spielen, Bauen, Turnen und Relaxen. Die MAXI Bausteine schulen Körperwahrnehmung und Motorik und regen zur Bewegung an. Sie bestehen aus weichem Schaumstoff und sind mit einem strapazierfähigen, pflegeleichten Kunstlederbezug versehen. Die Oberfläche des Kunstleders ist haptisch sehr angenehm und weich, was besonders für Babys und Kleinkinder geeignet ist. Ausserdem ist das Kunstleder einfach abwischbar mit Wasser und Neutralseife oder Kunstlederreiniger. Weitere wichtige Eigenschaften sind die Robustheit des Kunstleders (40000 Scheuertouren), die gute Lichtechtheit und dass das Kunstleder schwer entflammbar ist (nach DIN EN 1021-1). Die Bezüge sind ausserdem abnehmbar. Bei unseren neuen Kunstlederbausteinsätzen haben wir bewusst neue Farben gewählt. Wir setzen hier auf die Kombination aus hellen Pastelltönen und kräftigen Farben.

Art. 34-1021-KL kann in einem Weichbodenbezug verstaut werden. So haben Sie gleichzeitig einen Weichboden als Fallschutz (Unterseite des Weichbodens: rutschfester Turmmattenstoff).

Eigenschaften Kunstleder: Brennverhalten entspricht DIN EN 1021-1, Zigarettentest bestanden, phthalatfrei, 3 % PU, 81 % PVC, 16 % PES, 500g/m<sup>2</sup>

Those multifaceted modules are a year-round highlight in the nurseries. They are perfect to play with, to build, to do gymnastics or simply to relax. The MAXI modules educate body perception, motivity and encourage to movement. They are made of soft foam and they are covered with durable and carefree artificial leather. The surface of the artificial leather is haptically very enjoyable and soft. This is perfect for babies and infants. In addition the artificial leather is easy to clean with water and neutral soap or with an artificial leather cleaner. Other important features are the sturdiness (40000 martindale abrasions), the good light fastness and the low flammability (in acc. DIN EN 1021-1). The covers are removeable. We chose new colours attentive. We created combinations of light pastel shades and powerful colours. Item nr. 34-1021-KL can be stowed away in a landing mat cover. So you have a landing mat out of the module (bottom of the landing mat: anti-slip tarpaulin).

features artificial leather: flammability in accordance to DIN EN 1021-1, cigarette test passed, phthalates-free, 3 % PU, 81 % PVC, 16 % PES, 500g/m<sup>2</sup>

Farbpalette Kunstleder:  
colour palette artificial leather:



Sie erhalten weitere Bausteinsätze mit Kunstleder auf Anfrage.

Upon request you can get other module sets with artificial leather.





## 23-teiliger Bausteinsatz Kunstleder MINI

23 pcs. module set artificial leather MINI

Art. 95-550-KL

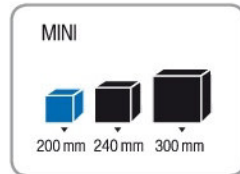

Block (verpackt)	block (packed)		
3 Quader	3 cuboids	■	1000 x 600 x 600 mm
4 Quader	4 cuboids	■	600 x 200 x 200 mm
2 halbe Ringe	2 half rings	■	600 x 200 x 100 mm
2 Dreiecksbrücken	2 triangle bridges	■	600 x 200 x 100 mm
4 Zylinder	4 cylinders	■	600 x 200 x 100 mm
2 Zylinder	2 cylinders	■	200 x Ø 200 mm
1 Zylinder	1 cylinder	■	400 x Ø 200 mm
4 Würfel	4 cubes	■	600 x Ø 200 mm
		■	200 x 200 x 200 mm

## 21-teiliger Bausteinsatz Kunstleder MAXI

21 pcs. module set artificial leather MAXI

Art. 34-1021-KL

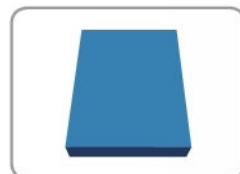
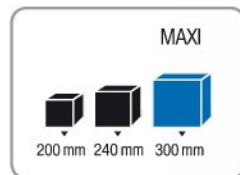

Art. 34-1026B-WB (Planenstoff, blau (tarpaulin, blue)),  
Weichbodenbezug für den 21-teiligen Bausteinsatz  
landing mat cover for the 21 pcs. module set

Block (verpackt)	block (packed)		
2 Dächer	2 roofs	■	1500 x 1500 x 300 mm
2 halbe Zylinder	2 half cylinders	■	600 x 600 x 300 mm
4 Brücken	4 bridges	■	300 x 300 x 150 mm
1 U-Element	1 U-element	■	600 x 300 x 300 mm
2 Quader	2 cuboids	■	600 x 600 x 300 mm
3 Quader	3 cuboids	■	600 x 300 x 150 mm
2 L-Elemente	2 L-elements	■	300 x 300 x 150 mm
1 Quader	1 cuboid	■	300 x 300 x 300 mm
2 Würfel	2 cubes	■	600 x 300 x 300 mm
2 L-Elemente	2 L-elements	■	300 x 300 x 300 mm
		■	600 x 300 x 300 mm

## Nicht das Richtige für Sie dabei?

Nothing here what you are looking for?

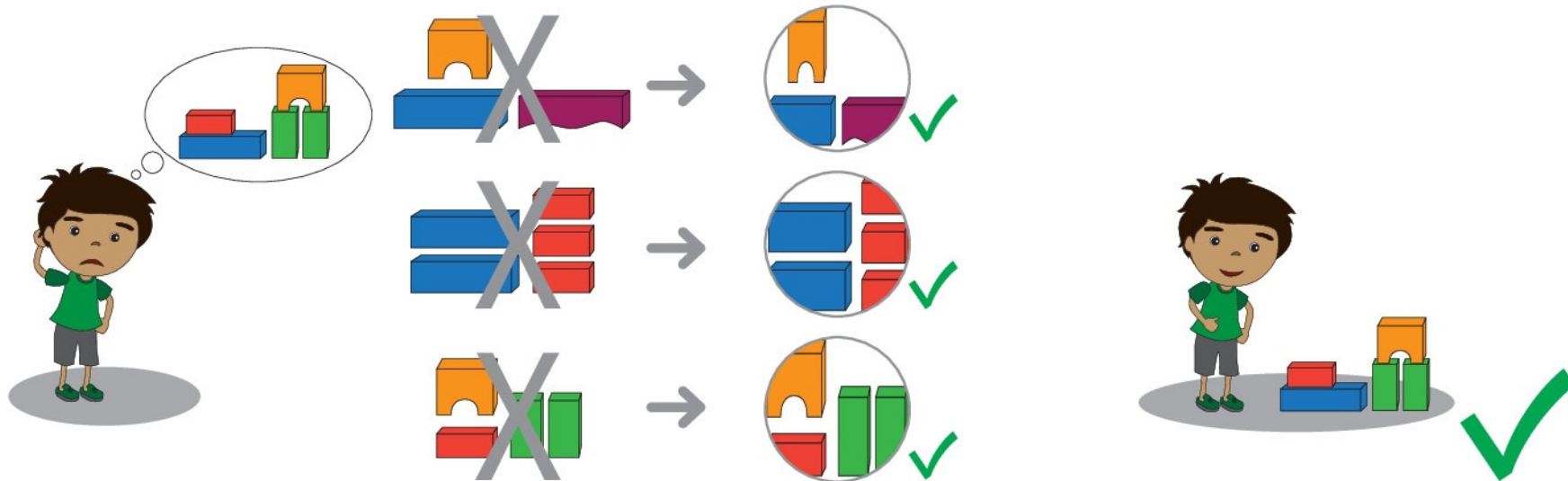

## Falscher Baustein, Größe oder Farbe?

Wrong module, size or colour?

Kein Problem. Neue Kompositionen oder andere Farben für einzelne Bausteine können nach Ihren Wünschen angefertigt werden. Variationen und Sonderanfertigungen sind immer möglich. Fragen Sie unser Verkaufsteam. Ein spezielles und unverbindliches Angebot wird Ihnen schnell erstellt. Sie finden Einzelteile aus unseren Baumodulen ab Seite 32.

Alle Produkte werden nach europäischen Qualitätsstandards gefertigt. Reparaturen von Bezügen werden schnell und unkompliziert in unserem Werk in Bad Wildungen ausgeführt.

No problem. We can manufacture new compositions or just other colours of single modules for you. Obvious different variations are possible, please do not hesitate to contact us. We would be glad to prepare a special offer for you. Of course it comes without any obligation. You will find single components from our element sets on page 32 and the following pages.

All products are manufactured according to European Quality Standards. Covering repairs will be handled fast and uncomplicatedly in our factory in Bad Wildungen.

# Baumodule

element sets

- 22 Baumodule MEDI
- 26 Baumodule MAXI
- 32 Baumodule Einzelteile
- 40 Konzept BeMo

- element sets MEDI
- element sets MAXI
- single components
- concept BeMo



Durch Krabbeln, Klettern, Laufen, Rutschen, Rollen und Springen steigt bei Kindern das eigene Selbstvertrauen und die Motivation zu weiterem Bewegen und Erleben. Die Bänfer Baumodule zielen genau darauf ab.

Leichtplanenstoff: schwer entflammbar, phthalatfrei, urin- und schweißbeständig, speichelecht  
 Schaum: Öko-TEX zertifiziert

Childrens's self confidence and motivation to move increases by crawling, climbing, running, sliding, weltering and jumping. The Bänfer element sets are geared towards that.

light tarpaulin: low flammability, phthalates-free, urine and sweat resistant, salivary resistant  
 foam: Oeko-TEX standard certified



Leichtplanenstoff  
light tarpaulin



flammhemmend  
flame-retarding



flüssigkeitsbeständig  
fluid resistant

## 3-teiliges Baumodul MEDI

3 pcs. element set MEDI

Art. 36-170-12

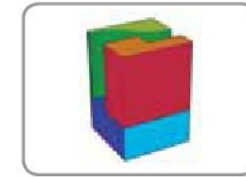
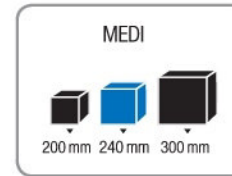
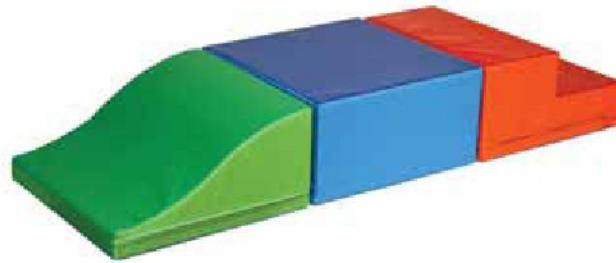

1 Wellenkeil	1 wave wedge		480 x 480 x 240/40 mm	36-108-12
1 Quader	1 cuboid		480 x 480 x 240 mm	36-101-12
1 Treppe	1 stairs		480 x 480 x 240/120 mm	36-107-12

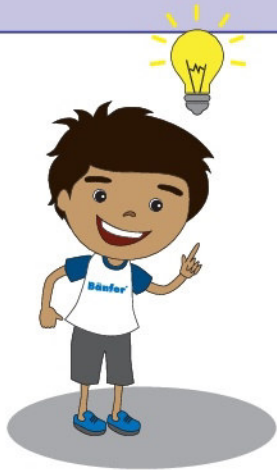

Alle Einzelteile dieser Seite sind nach dem Größenschema MEDI entwickelt.  
Wir empfehlen Kombinationen mit gleichem Größenschema.

All items of the page are under the size schematatic MEDI developed.  
We recommend combinations with the same size schematic.

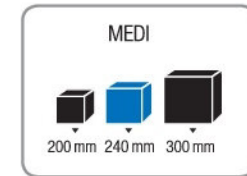

## 4-teiliges Baumodul MEDI

4 pcs. element set MEDI

Art. 36-180-12

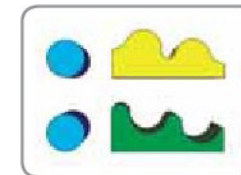
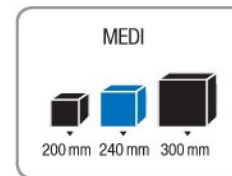
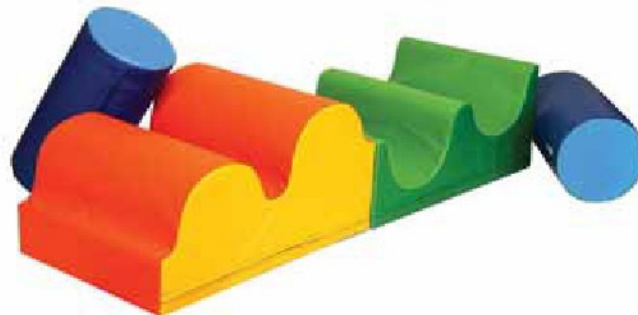

1 positive Welle	1 positive wave		720 x 480 x 280 mm	36-123-12
1 negative Welle	1 negative wave		480 x 720 x 240 mm	36-124-12
2 Zylinder	2 cylinders		480 x Ø 240 mm	36-111-12

## 4-teiliges Baumodul MEDI

4 pcs. element set MEDI

Art. 36-190-12

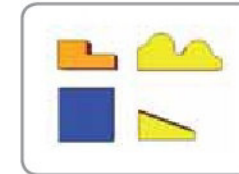
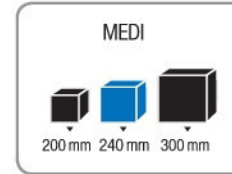

1 Keil	1 wedge		480 x 480 x 240/60 mm	36-105-12
1 Quader	1 cuboid		480 x 480 x 240 mm	36-101-12
1 Treppe	1 stairs		480 x 480 x 240/120 mm	36-107-12
1 positive Welle	1 positive wave		720 x 480 x 280 mm	36-123-12

## 5-teiliges Baumodul MEDI

5 pcs. element set MEDI

Art. 36-160-12

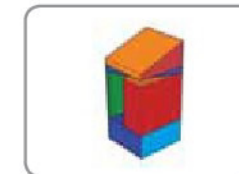
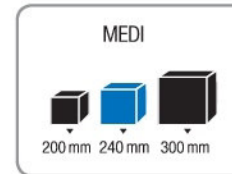

1 Wellenkeil	1 wave wedge		480 x 480 x 240/40 mm	36-108-12
1 Keil	1 wedge		480 x 480 x 240/60 mm	36-105-12
1 Viertelkreismatte	1 quarter circle mat		480 x 480 x 60 mm	36-130-12
1 Treppe	1 stairs		480 x 480 x 240/120 mm	36-107-12
1 Quader	1 cuboid		480 x 480 x 240 mm	36-101-12

## 5-teiliges Baumodul MEDI

5 pcs. element set MEDI

Art. 36-150-12

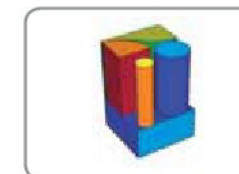
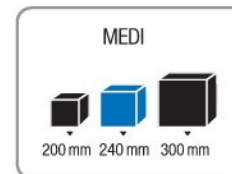
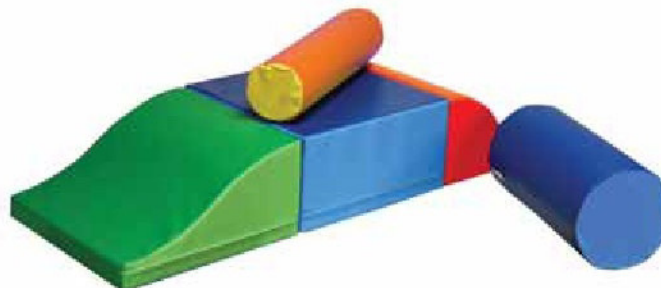

1 Wellenkeil	1 wave wedge		480 x 480 x 240/40 mm	36-108-12
1 Quader	1 cuboid		480 x 480 x 240 mm	36-101-12
1 Viertelzylinder	1 quarter cylinder		480 x 240 x 240 mm	36-109-12
1 Zylinder	1 cylinder		480 x Ø 120 mm	36-112-12
1 Zylinder	1 cylinder		480 x Ø 240 mm	36-111-12

## 8-teiliges Baumodul MEDI

8 pcs. element set MEDI

Art. 36-165-12

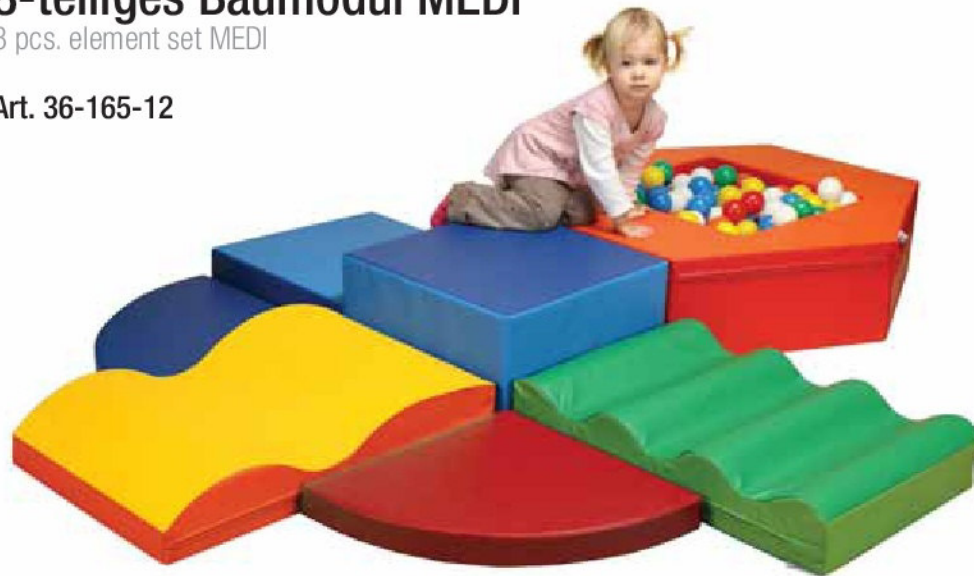

Dieses Baumodul wird ohne Bälle geliefert. Bälle: siehe Seite 48.  
The element set comes without balls. Balls: see page 48.

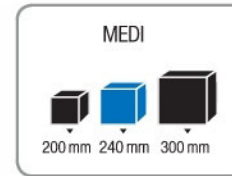

1 Viertelkreismatte	1 quater circle mat		Ø 960 x 60 mm	36-138-12
1 Viertelkreismatte	1 quater circle mat		Ø 960 x 60 mm	36-130-12
1 Quader	1 cuboid		480 x 480 x 120 mm	36-100-12
1 Welle (4 Höhen)	1 wave (4 peaks)		720 x 480 x 100 mm	36-122-12
1 Welle (2 Höhen)	1 wave (2 peaks)		720 x 480 x 100 mm	36-121-12
2 halbe Sechsecke	2 half hexagons		960 x 480 x 240 mm	36-126-12
1 Quader	1 cuboid		480 x 480 x 240 mm	36-101-12

## 9-teiliges Baumodul MEDI

9 pcs. element set MEDI

Art. 95-145-12

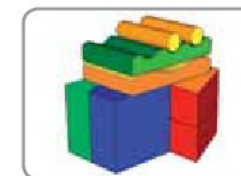
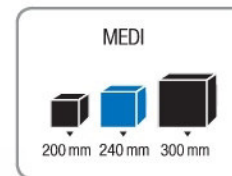

1 Hügel	1 hill		480 x 480 x 365 mm	36-115-12
1 Tal	1 valley		480 x 480 x 240 mm	36-116-12
1 Quader	1 cuboid		480 x 480 x 240 mm	36-101-12
1 Welle (4 Höhen)	1 wave (4 peaks)		720 x 480 x 100 mm	36-122-12
1 Welle (2 Höhen)	1 wave (2 peaks)		720 x 480 x 100 mm	36-121-12
2 halbe Sechsecke	2 half hexagons		960 x 480 x 240 mm	36-126-12
2 Zylinder	2 cylinders		480 x Ø 120 mm	36-112-12

## 9-teiliges Baumodul MEDI

9 pcs. element set MEDI

Art. 36-175-12

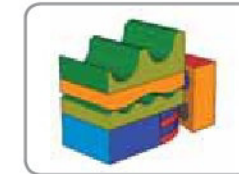
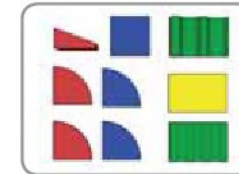
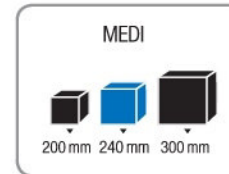

1

Der Tastkeil ist mit Haftband, Filz, Flauschband und einem Spiegel zum Entdecken ausgestattet  
The feel wedge is equipped with adhesive tape, felt, nap and a mirror to explore.

1 Tastkeil	1 feel wedge		480 x 480 x 240/60 mm	36-105-TA-12
1 Quader	1 cuboid		480 x 480 x 240 mm	36-101-12
1 Welle (4 Höhen)	1 wave (4 peaks)		720 x 480 x 100 mm	36-122-12
1 Welle (2 Höhen)	1 wave (2 peaks)		720 x 480 x 100 mm	36-121-12
2 Viertelkreismatten	2 quarter circle mats		Ø 960 x 60 mm	36-130-12
2 Viertelkreismatten	2 quarter circle mats		Ø 960 x 60 mm	36-138-12
1 negative Welle	1 negative wave		480 x 720 x 240 mm	36-124-12

## 10-teiliges Baumodul MEDI

10 pcs. element set MEDI

Art. 95-155-12

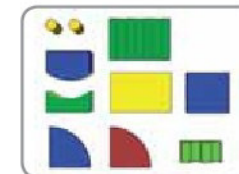
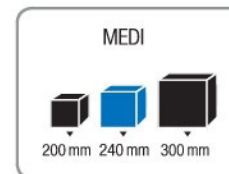

1 Hügel	1 hill		480 x 480 x 365 mm	36-115-12
1 Tal	1 valley		480 x 480 x 240 mm	36-116-12
1 Quader	1 cuboid		480 x 480 x 240 mm	36-101-12
1 Welle (4 Höhen)	1 wave (4 peaks)		720 x 480 x 100 mm	36-122-12
1 Welle (2 Höhen)	1 wave (2 peaks)		720 x 480 x 100 mm	36-121-12
1 negative Welle	1 negative wave		960 x 480 x 240 mm	36-124-12
2 Zylinder	1 cylinders		480 x Ø 120 mm	36-112-12
1 Viertelkreismatte	1 quarter circle mat		Ø 960 x 60 mm	36-138-12
1 Viertelkreismatte	1 quarter circle mat		Ø 960 x 60 mm	36-130-12

## 3-teiliges Baumodul MAXI

3 pcs. element set MAXI

Art. 36-1007-16

 Die Einzelteile dieses Baumoduls sind mit Klettverbindungen ausgestattet.  
The single components of this element set have Velcro® connection.

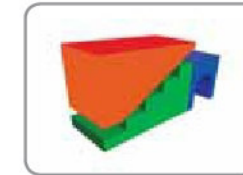
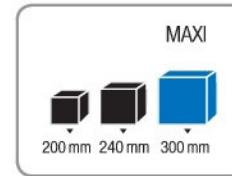

1 große Treppe  
1 Tunnel  
1 großer Keil

1 big stairs  
1 tunnel  
1 big wedge



600 x 1200 x 600/120 mm  
600 x 600 x 600 mm  
600 x 1200 x 600/60 mm

34-102-12  
34-109-12  
34-101-12

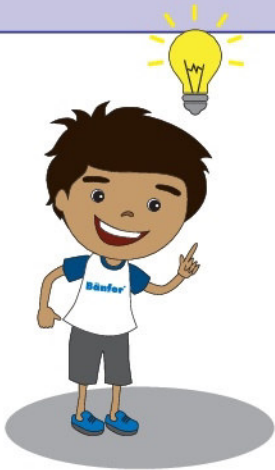

Alle Einzelteile dieser Seite sind nach dem Größenschema MAXI entwickelt.  
Wir empfehlen Kombinationen mit gleichem Größenschema.

All items of the page are under the size schematic MAXI developed.  
We recommend combinations with the same size schematic.

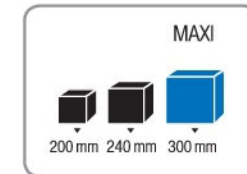

## 3-teiliges Baumodul MAXI

3 pcs. element set MAXI

Art. 36-370-12

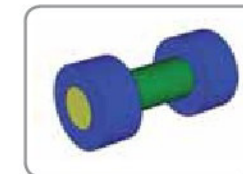
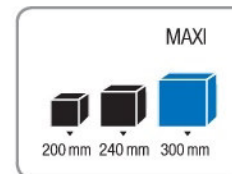

2 Ringe

2 rings



Innen: Ø 300 mm  
Außen: Ø 600 mm  
1200 x Ø 300 mm

34-043-12

1 Zylinder

1 cylinder



34-202-12



## 3-teiliges Baumodul MAXI

3 pcs. element set MAXI

Art. 36-260-12

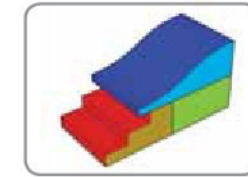
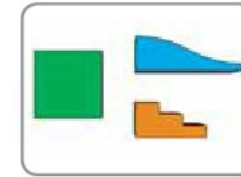
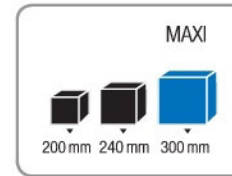
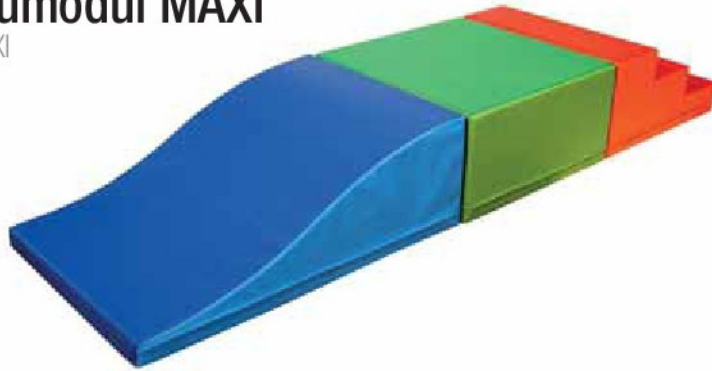

1 Wellenkeil  
1 Quader  
1 Treppe

1 wave wedge  
1 cuboid  
1 stairs



900 x 600 x 300/60 mm  
600 x 600 x 300 mm  
600 x 600 x 300/100 mm

36-215-12  
34-022-12  
36-208A-12

## 3-teiliges Baumodul MAXI

3 pcs. element set MAXI

Art. 34-1000-16

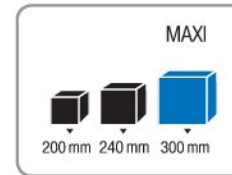

2 U-Elemente  
1 großer Ring

2 U-elements  
1 big ring



600 x 600 x 300/300 mm  
Innen: 300 x Ø 600 mm  
Außen: 300 x Ø 1200 mm

34-045-12  
34-042-12

## 4-teiliges Baumodul MAXI

4 pcs. element set MAXI

Art. 36-350-12

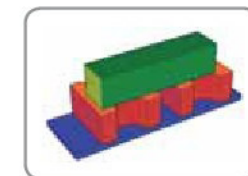
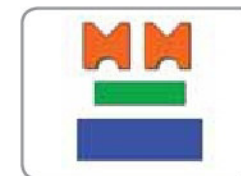
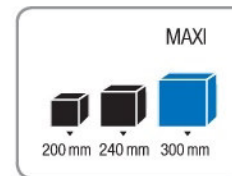

2 Doppelbrücken  
1 Quader  
1 Turnmatte

2 double bridges  
1 cuboid  
1 mat



600 x 600 x 300 mm  
1200 x 300 x 300 mm  
1800 x 600 x 60 mm

36-217-12  
34-202-12  
34-018-12

## 4-teiliges Baumodul MAXI

4 pcs. element set MAXI

Art. 34-001-12

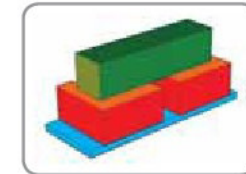
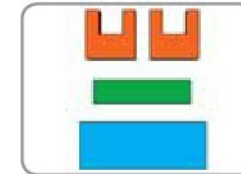
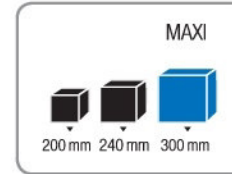

2 U-Elemente  
1 Quader  
1 Turnmatte

2 U-elements  
1 cuboid  
1 mat



600 x 600 x 300/300 mm  
1200 x 300 x 300 mm  
1600 x 600 x 60 mm

34-045-12  
34-200-12  
34-016-12

## 4-teiliges Baumodul MAXI

4 pcs. element set MAXI

Art. 36-360-12

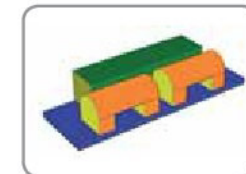
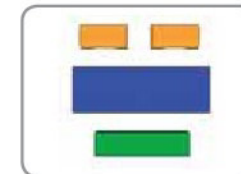
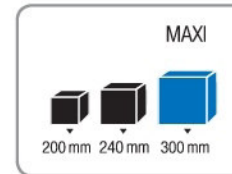
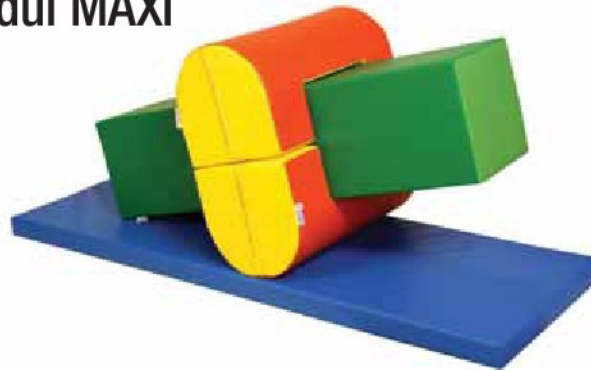

1 Quader  
2 Brücken  
1 Turnmatte

1 cuboid  
2 bridges  
1 mat



1200 x 300 x 300 mm  
600 x 600 x 300 mm  
1800 x 600 x 60 mm

34-200-12  
34-219B-12  
34-018-12

## 4-teiliges Baumodul MAXI

4 pcs. element set MAXI

Art. 34-1003-12

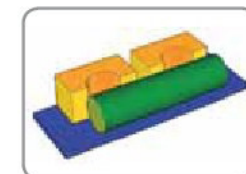
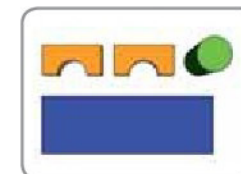
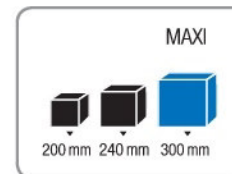

2 Brücken  
1 Zylinder  
1 Turnmatte

2 bridges  
1 cylinder  
1 mat



600 x 600 x 300 mm  
1200 x Ø 300 mm  
1800 x 600 x 60 mm

34-090-12  
34-202-12  
34-018-12

## 5-teiliges Baumodul MAXI

5 pcs. element set MAXI

Art. 34-002-12

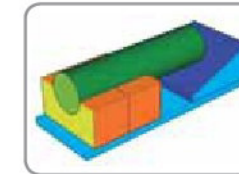
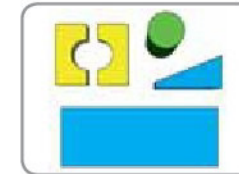
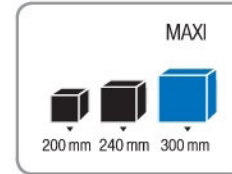

2 Brücken  
1 Zylinder  
1 Keil  
1 Turnmatte

2 bridges  
1 cylinder  
1 wedge  
1 mat



600 x 600 x 300 mm  
1200 x Ø 300 mm  
600 x 600 x 300/60 mm  
1600 x 600 x 60 mm

34-090-12  
34-202-12  
34-086B-12  
34-016-12

## 5-teiliges Baumodul MAXI

5 pcs. element set MAXI

Art. 34-1010-12

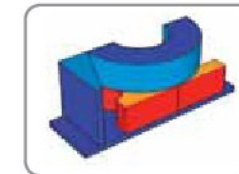
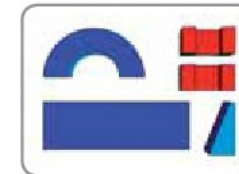
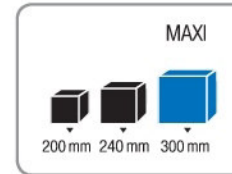

2 U-Element-Brücken  
1 halber Ring  
1 Keil  
1 Turnmatte

2 U-element bridges  
1 half ring  
1 wedge  
1 mat



600 x 600 x 300/300 mm  
300 x 300 x Ø 1200 mm  
600 x 600 x 300/60 mm  
1800 x 600 x 60 mm

34-106-12  
34-030-12  
34-086B-12  
34-018-12

## 5-teiliges Baumodul MAXI

5 pcs. element set MAXI

Art. 36-250-12

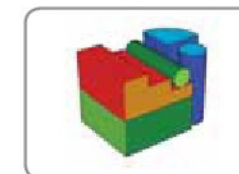
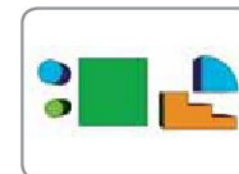
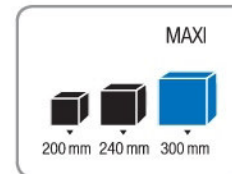
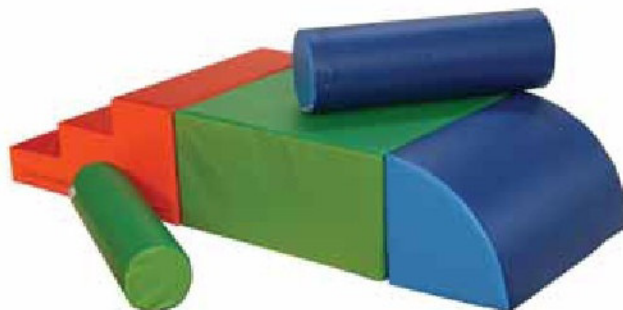

1 Treppe  
1 Quader  
1 Zylinder  
1 Zylinder  
1 Viertelzylinder

1 stairs  
1 cuboid  
1 cylinder  
1 cylinder  
1 quater cylinder



600 x 600 x 300/100 mm  
600 x 600 x 300 mm  
600 x Ø 200 mm  
600 x Ø 150 mm  
600 x 300 x 300 mm

36-208A-12  
34-022-12  
36-212B-12  
36-212A-12  
36-224-12

## 6-teiliges Baumodul MAXI

6 pcs. element set MEDI

Art. 34-006-12

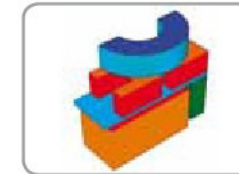
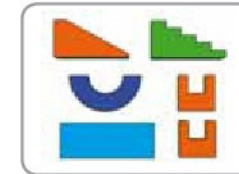
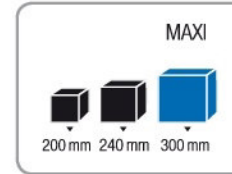

1 große Treppe	1 big stairs		600 x 1200 x 600/120 mm	34-102-12
1 großer Keil	1 big wedge		600 x 1200 x 600/60 mm	34-101-12
2 U-Elemente	2 U-elements		600 x 600 x 300 mm	34-045-12
1 halber Ring	1 half ring		300 x 300 x Ø 1200 mm	34-030-12
1 Turnmatte	1 mat		1600 x 600 x 60 mm	34-016-12

## 9-teiliges Baumodul MAXI

9 pcs. element set MEDI

Art. 34-003-16

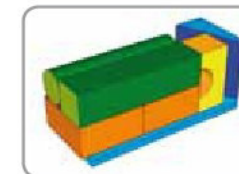
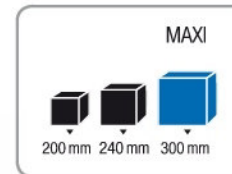

1 Keil	1 wedge		600 x 600 x 300/60 mm	34-086B-12
2 U-Element-Brücken	2 U-element bridges		600 x 600 x 300/300 mm	34-106-12
1 Quader	1 cuboid		1200 x 300 x 300 mm	34-200-12
2 Brücken	2 bridges		600 x 300 x 300 mm	34-090-12
1 Zylinder	1 cylinder		1200 x Ø 300 mm	34-202-12
2 Turnmatten	2 mats		1600 x 600 x 60 mm	34-016-12

## 10-teiliges Baumodul MAXI

10 pcs. element set MEDI

Art. 34-1009-12

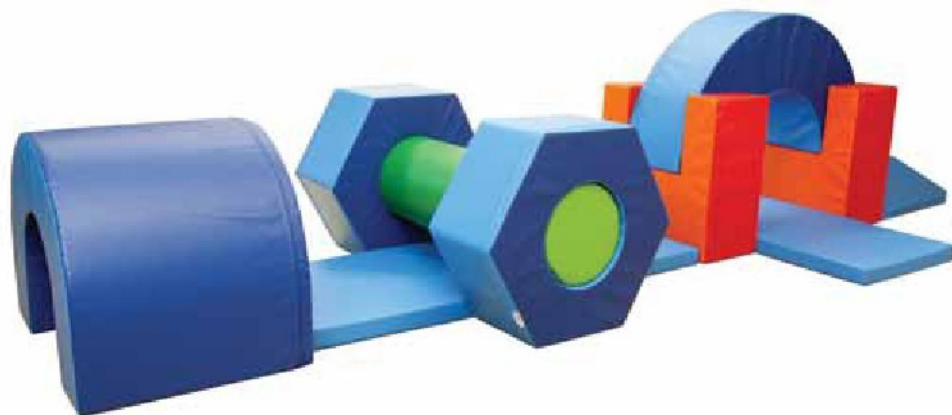
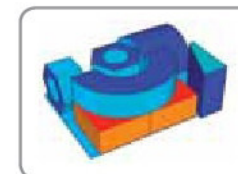
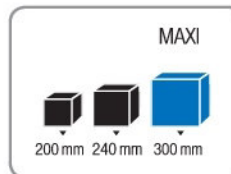

1 Keil	1 wedge		600 x 600 x 300/60 mm	34-086B-12
2 U-Elemente	2 U-elements		600 x 600 x 300/300 mm	34-045-12
1 halber Ring	1 half ring		300 x 300 x Ø 1200 mm	34-030-12
2 Sechseck-Ringe	2 hexagon rings		600 x 600 x 300 mm	34-044-12
1 Zylinder	1 cylinder		1200 x Ø 300 mm	34-202-12
1 Tunnel	1 tunnel		600 x 800 x 600 mm	36-218-12
2 Turnmatten	2 mats		1600 x 600 x 60 mm	34-016-12

## 11-teiliges Baumodul MAXI

11 pcs. element set MEDI

Art. 34-005-12

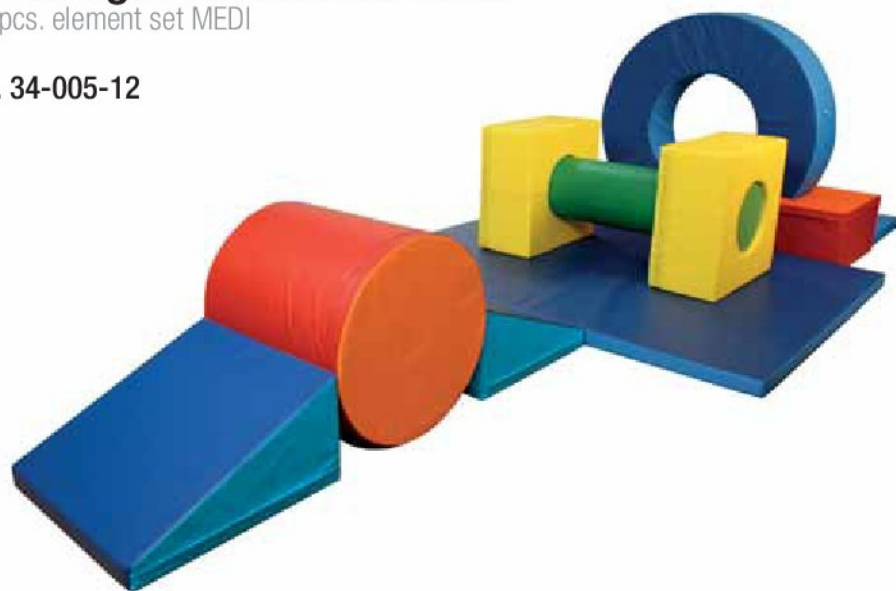
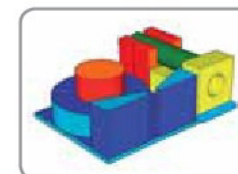
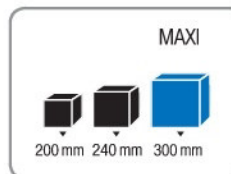

2 Keile	2 wedges		600 x 600 x 300/60 mm	34-086B-12
2 U-Elemente	2 U-elements		600 x 600 x 300/300 mm	34-045-12
1 großer Ring	1 big ring		Innen: 300 x Ø 600 mm Außen: 300 x Ø 1200 mm	34-042-12
2 Quader-Ringe	2 cuboid rings		600 x 600 x 300 mm	34-094-12
1 Zylinder	1 cylinder		600 x Ø 600 mm	36-221-12
1 Zylinder	1 cylinder		1200 x Ø 300 mm	36-202-12
1 Turnmatte	1 mat		1600 x 600 x 60 mm	34-016-12
1 Turnmatte	1 mat		2000 x 1500 x 60 mm	34-015-12

# Einzelteile MEDI

components MEDI

Maßangaben in mm  
measurements in mm

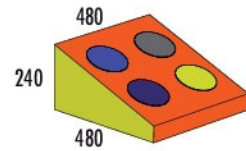

Art. Nr. 36-105ta-12

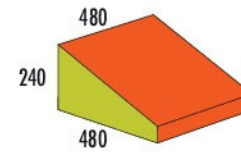

Art. Nr. 36-105-12

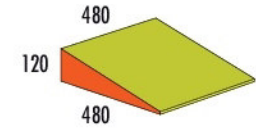

Art. Nr. 36-106-12

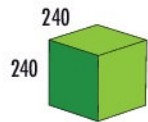

Art. Nr. 36-103-12

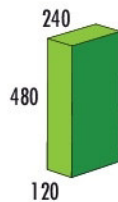

Art. Nr. 36-104-12

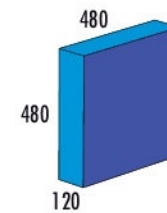

Art. Nr. 36-100-12

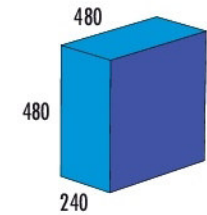

Art. Nr. 36-101-12

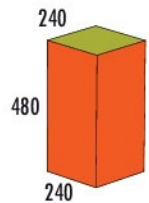

Art. Nr. 36-102-12

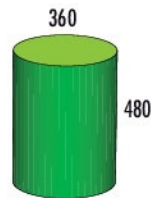

Art. Nr. 36-110-12

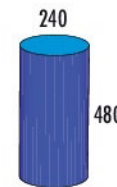

Art. Nr. 36-111-12

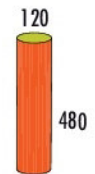

Art. Nr. 36-112-12

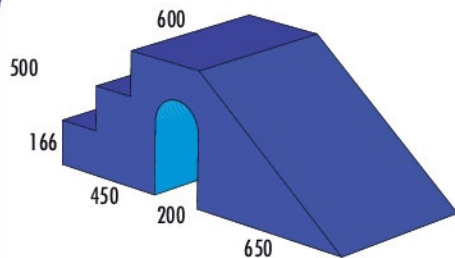

Art. Nr. 36-132-12

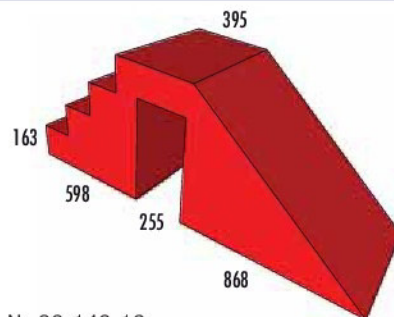

Art. Nr. 36-146-12

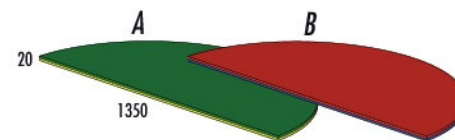

Art. Nr. 36-133 A-12

Art. Nr. 36-133 B-12

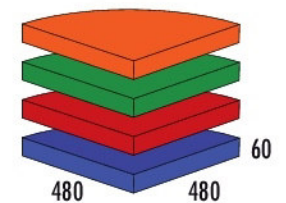

Art. Nr. 36-130-12

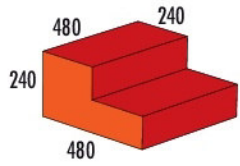

Art. Nr. 36-107-12

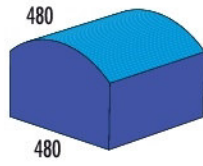

Art. Nr. 36-115-12

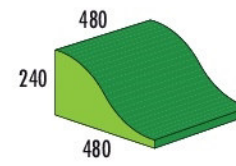

Art. Nr. 36-108-12

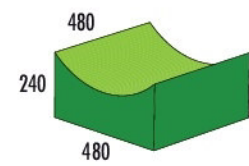

Art. Nr. 36-116-12

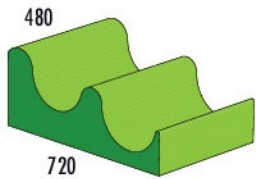

Art. Nr. 36-124-12

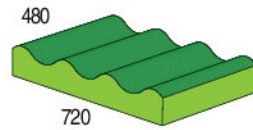

Art. Nr. 36-122-12

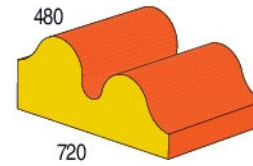

Art. Nr. 36-123-12

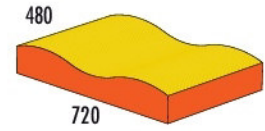

Art. Nr. 36-121-12



Art. Nr. 36-120-12

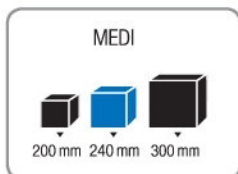

Alle Einzelteile dieser Seite sind nach dem Größenschema MEDI entwickelt.  
Wir empfehlen Kombinationen mit gleichem Größenschema.

All items of the page are under the size schematatic MEDI developed.  
We recommend combinations with the same size schematic.



# Einzelteile MAXI

components MAXI

Maßangaben in mm  
measurements in mm

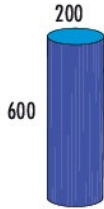

Art. Nr. 36-211B-12

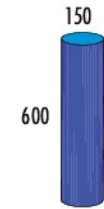

Art. Nr. 36-212B-12

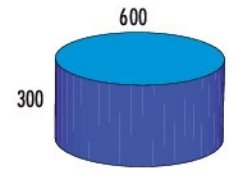

Art. Nr. 36-222-12

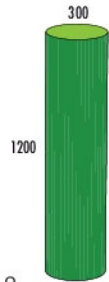

Art. Nr. 34-202-12

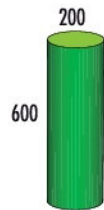

Art. Nr. 36-211A-12

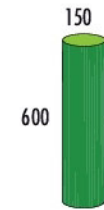

Art. Nr. 36-212A-12

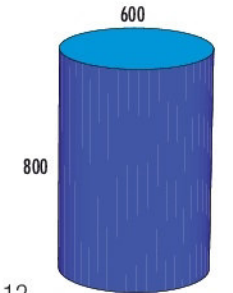

Art. Nr. 36-220-12

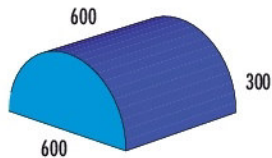

Art. Nr. 36-223-12

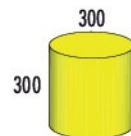

Art. Nr. 34-077-12

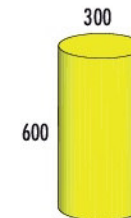

Art. Nr. 34-075-12

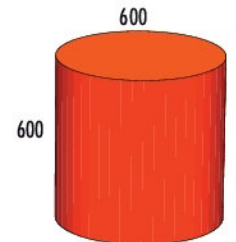

Art. Nr. 36-221-12

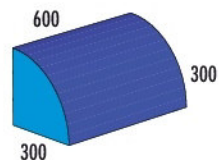

Art. Nr. 36-224-12

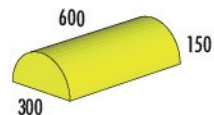

Art. Nr. 34-067-12

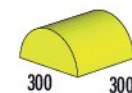

Art. Nr. 34-065-12

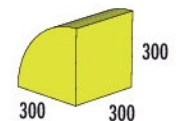

Art. Nr. 34-060-12



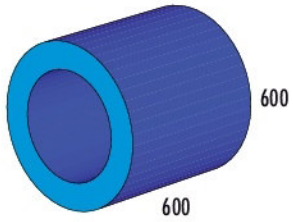

Art. Nr. 36-127-12

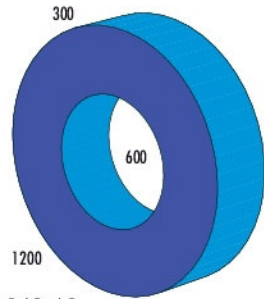

Art. Nr. 34-042-12

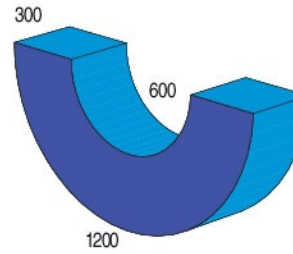

Art. Nr. 34-030-12

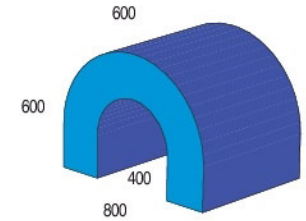

Art. Nr. 36-218-12

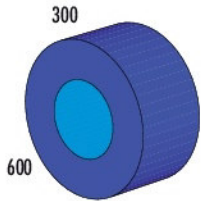

Art. Nr. 34-043-12

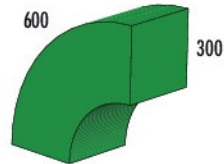

Art. Nr. 34-059-12

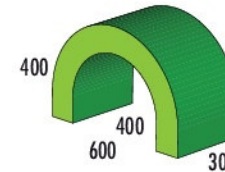

Art. Nr. 36-125-12

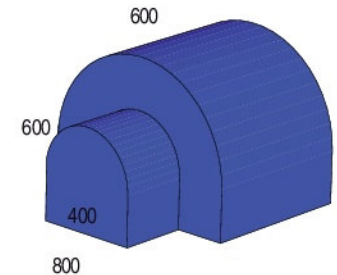

Art. Nr. 34-096-12

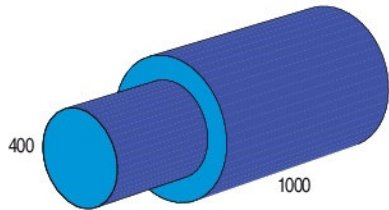

Art. Nr. 34-076-12

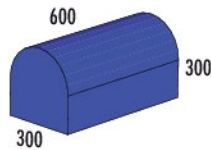

Art. Nr. 34-008-12

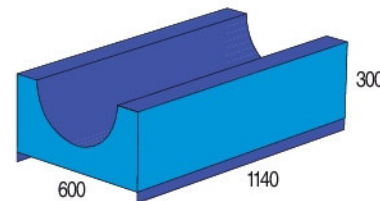

Art. Nr. 34-108-12

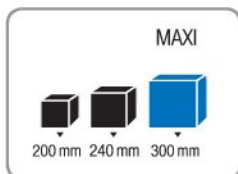

Alle Einzelteile dieser Seite sind nach dem Größenschema MAXI entwickelt.  
Wir empfehlen Kombinationen mit gleichem Größenschema.

All items of the page are under the size schematic MAXI developed.  
We recommend combinations with the same size schematic.



# Einzelteile MAXI

components MAXI

Maßangaben in mm  
measurements in mm

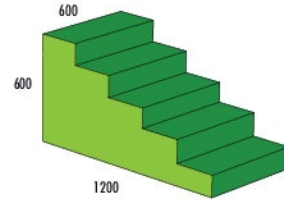

Art. Nr. 34-102-12

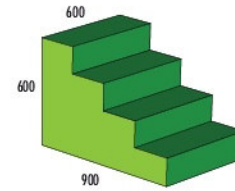

Art. Nr. 36-209A-12

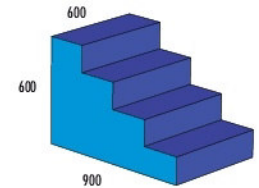

Art. Nr. 36-209B-12

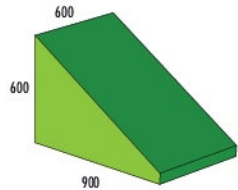

Art. Nr. 36-205A-12

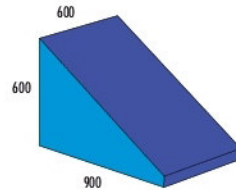

Art. Nr. 36-205B-12

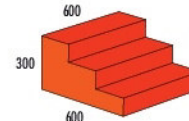

Art. Nr. 36-208A-12

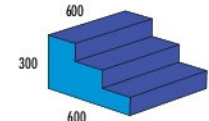

Art. Nr. 36-208B-12

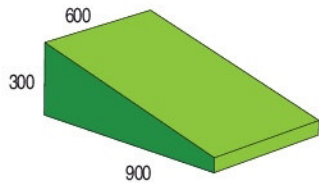

Art. Nr. 36-206A-12

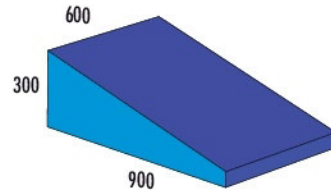

Art. Nr. 36-206B-12

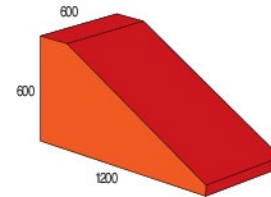

Art. Nr. 34-101-12

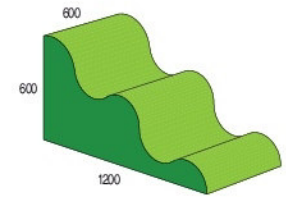

Art. Nr. 34-105-12

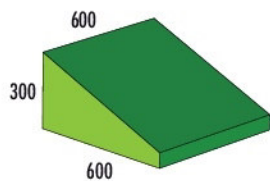

Art. Nr. 34-086A-12

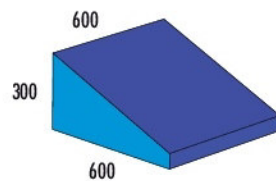

Art. Nr. 34-086B-12

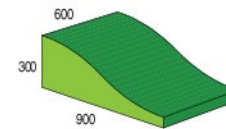

Art. Nr. 36-215 A-12

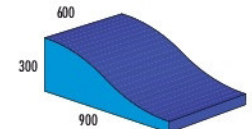

Art. Nr. 36-215 B-12

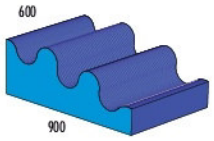

Art. Nr. 36-214-12

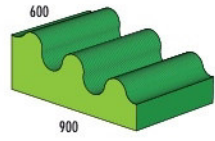

Art. Nr. 36-213-12

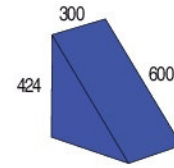

Art. Nr. 34-035-12

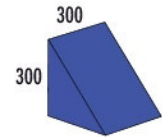

Art. Nr. 34-032-12

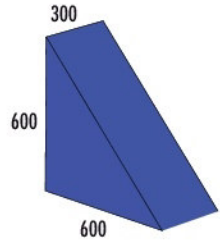

Art. Nr. 34-036-12

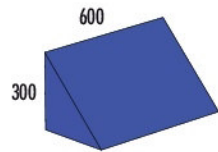

Art. Nr. 34-028-12

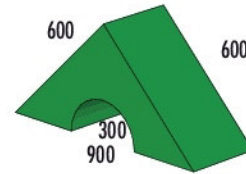

Art. Nr. 34-038-12



Art. Nr. 34-037-12

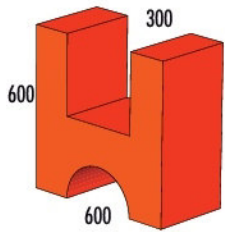

Art. Nr. 34-106-12

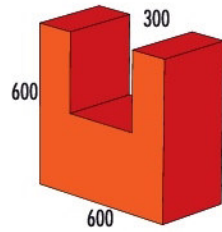

Art. Nr. 34-045-12

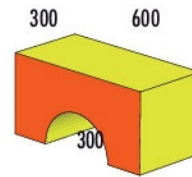

Art. Nr. 34-090-12

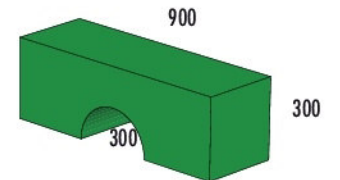

Art. Nr. 34-093-12

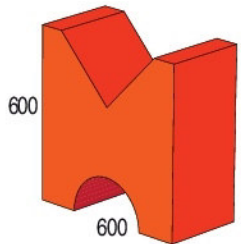

Art. Nr. 36-217-12

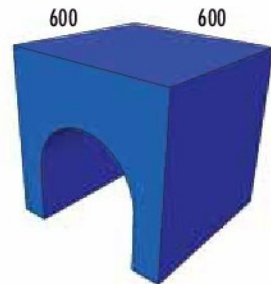

Art. Nr. 34-109-12

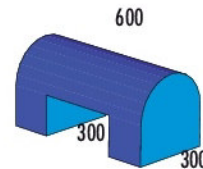

Art. Nr. 36-219B-12

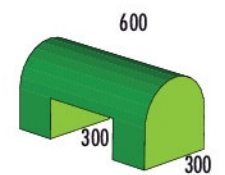

Art. Nr. 36-219A-12

# Einzelteile MAXI

components MAXI

Maßangaben in mm  
measurements in mm

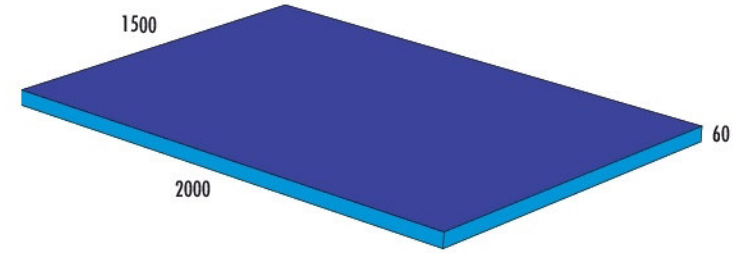

Art. Nr. 34-015-12

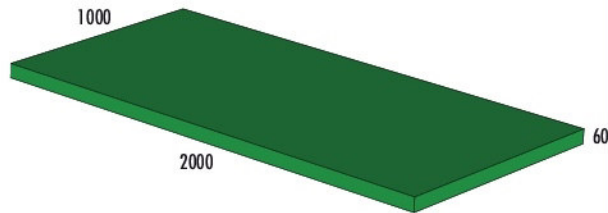

Art. Nr. 34-014-12

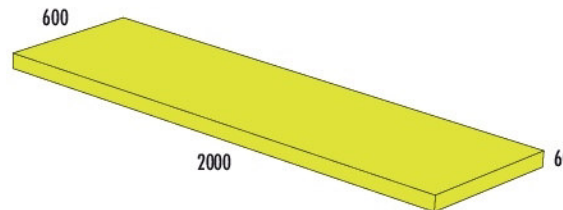

Art. Nr. 34-013-12

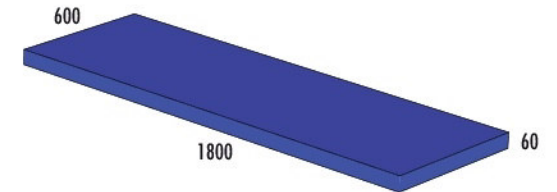

Art. Nr. 34-018-12

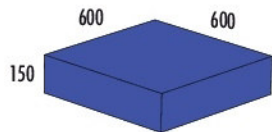

Art. Nr. 36-201-12

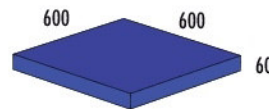

Art. Nr. 34-011-12

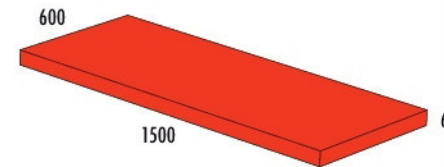

Art. Nr. 34-012-12

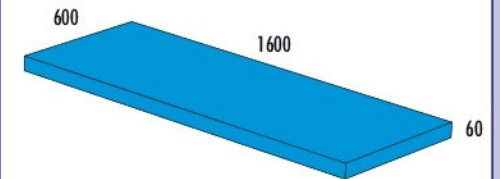

Art. Nr. 34-016-12

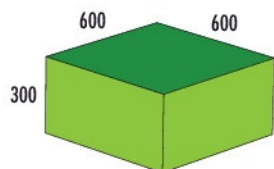

Art. Nr. 34-022-12

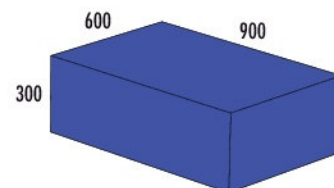

Art. Nr. 36-203-12

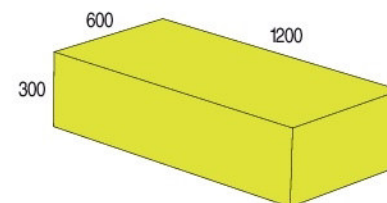

Art. Nr. 34-023-12

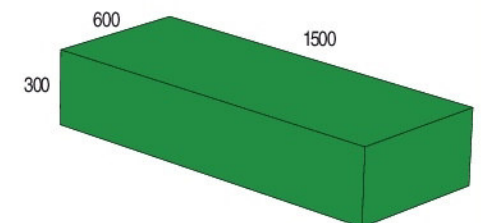

Art. Nr. 34-024-12

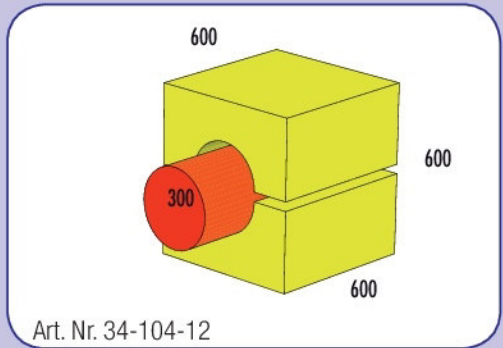
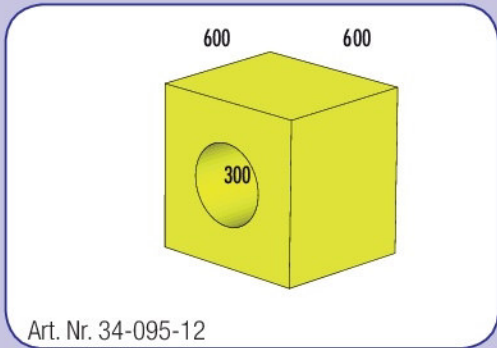
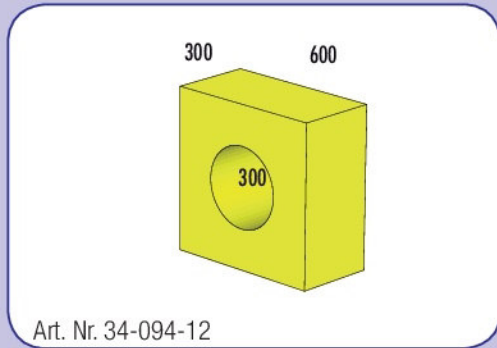
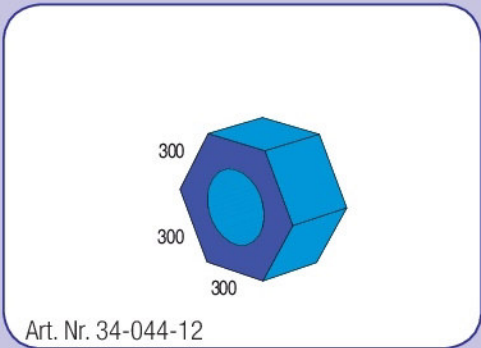
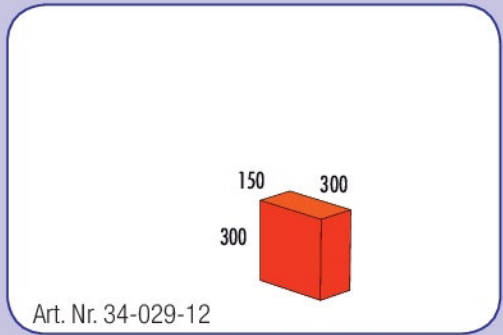
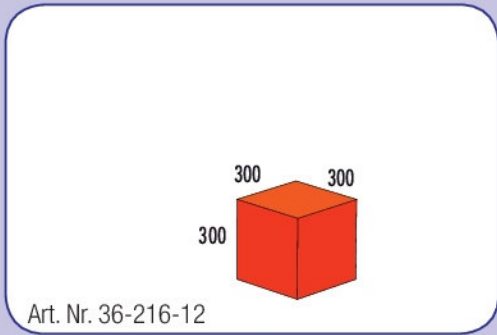
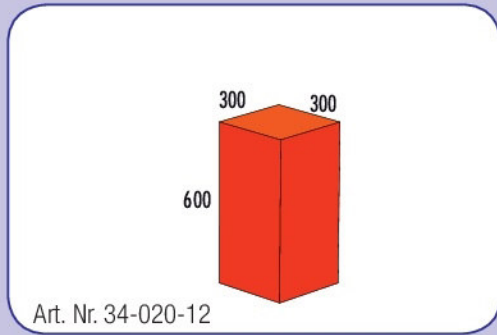
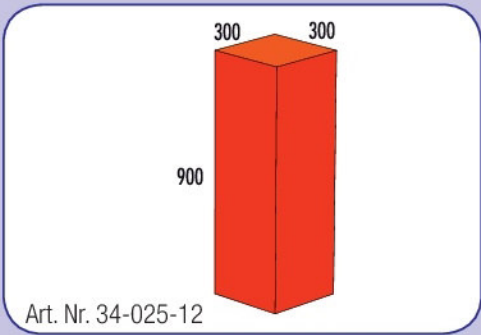
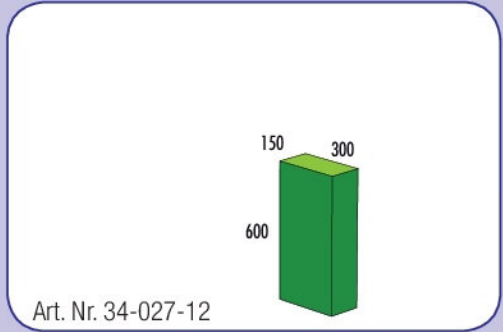
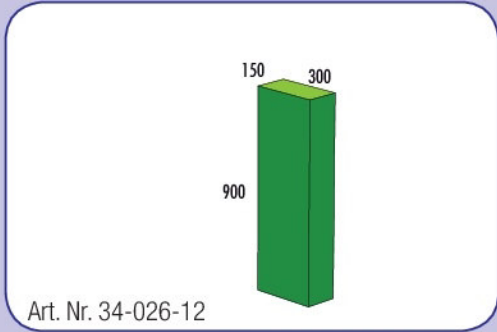
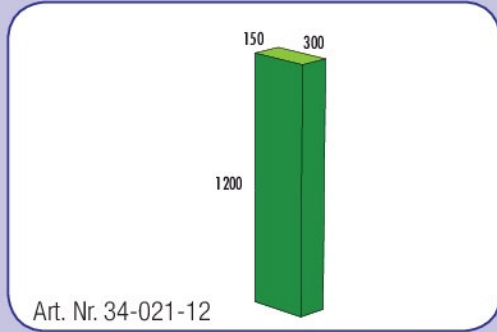
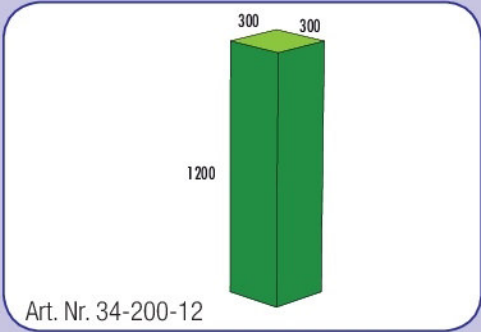
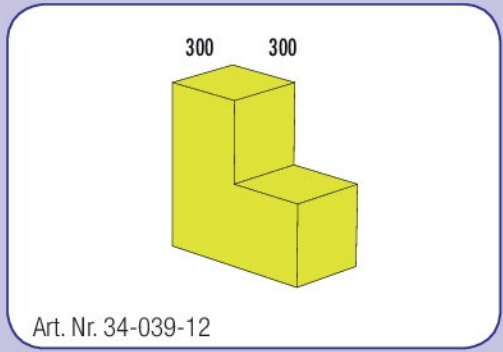
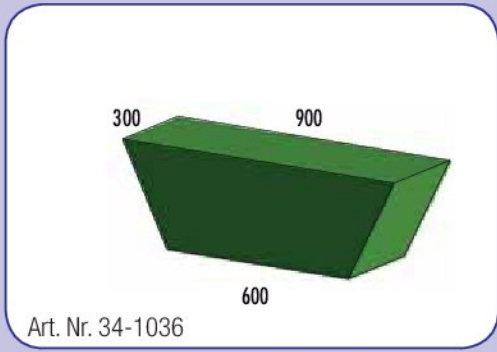
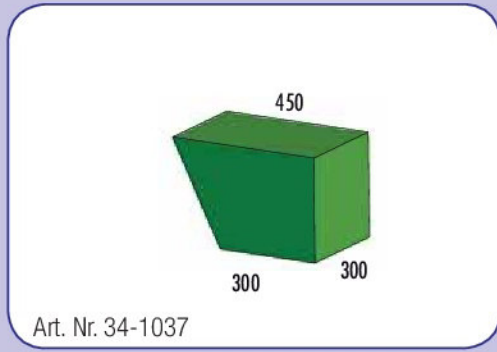
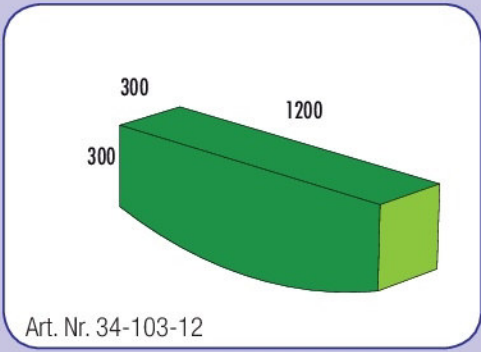

# Bewegungsbaustelle – Konzept BeMo

movement site – concept BeMo



Bänfer möchte nicht nur weitere Baumodule auf den Markt bringen, sondern einen Mehrwert der Module schaffen. Zusammenhängende Module mit Multifunktionalität sind das Ziel. Umnutzung, Mehrfachnutzung, Zusammensetzung und Themenwelten sind hier nur einige der Schlagworte. Auch kleineren Einrichtungen soll, durch eine optimale Raumnutzung, die Möglichkeit gegeben werden platzsparende Module zu verwenden. Nicht nur das Toben und Spielen soll gefördert werden, sondern auch die Ruhephasen bestimmt werden. Die Module sind so konzipiert, dass die Erzieher schnell und einfach bestimmen, wann und ob gespielt wird, z.B. durch die Abdeckung des Bällebades wird ein Schlafplatz geschaffen und die Kinder werden nicht mehr von den vielen bunten Bällen abgelenkt. Unsere Bewegungsmodule wurden mit dem Zertifikat „Bewegte Innovation“ ausgezeichnet.

MagCon ist die neue patentierte Verbindung von Bausteinen mit Magnetstreifen. Die eingebauten Magnete (unter dem orangefarbenen Planenstoff) bieten zusätzliche Funktionen, wie das Kombinieren und Verbinden einzelner Bausteine. Weiterhin entfällt die lästige Verschmutzung, welche bei Klettecken ab einer gewissen Zeit üblich ist. Dabei gehen keine Funktionen der einzelnen Bausteine verloren, da die Magnete optimal unter dem Planenstoff verschwinden und keine gefährlichen Ecken und Kanten entstehen.

Leichtplanenstoff: schwer entflammbar, phthalatfrei, urin- und schweißbeständig, speichelecht  
 Schaum: z.T. Öko-TEX zertifiziert

Bänfer does not just want to launch a new element set, we want to create an overvalue for the modules. Related multifunctional modules are the aim. Conversion, multiple use, combination and theme worlds are just some of the catchwords. Also smaller kindergartens shall have the opportunity to enjoy the sets and to have an optimal space utilization. So there is a high attention on space-saving modules. Not only the cavort and play situation should be promoted but also the calm situation. The module sets are designed to create and convert easily different situations. For example, the ball pool has a cap. So the playful situation can be changed to a calm sleeping place or just hide the balls to stop the distraction. Our movement modules are certified with „Movement and Innovation“.

MagCon is the new patented connection of bricks with magnetic strips. The built-in magnets (under the orange coloured canvas) have more functions like to combine single bricks. Another advantage that there is no dirtying of the usual Velcro what is common after a certain time of use. The single bricks do not loose a function. In addition, the magnets are hidden under the sleeve and there are no hazardous corners or edges.

light tarpaulin: low flammability, phthalates-free, urine and sweat resistant, salivary resistant  
 foam: partly Oeko-TEX standard certified



Leichtplanenstoff  
light tarpaulin



flammschützend  
flame-retarding



flüssigkeitsbeständig  
fluid resistant



Magnetverbindung  
magnetic connection



## Zertifikat: „Bewegte Innovation“

certificate „movement & innovation“



## weitere Zertifikate

more certificates



„Innovative Spielgeräte sind ein zentraler Motor für die kindliche Entwicklungsförderung. Das „Bewegen“ übernimmt hier Schrittmacherfunktionen und verlinkt Entwicklungspotenziale verschiedener Dimensionen (v.a. emotionale, kognitive, soziale Entwicklung). In den zurückliegenden Jahren sind zahlreiche Geräte und Bewegungskonzepte auf den Markt gekommen, die geeignet sind, die kindliche Entwicklung in spielerischer und ganzheitlicher Weise zu fördern.

Um in diesem Feld Überblick zu ermöglichen, bieten wir in unserer Arbeit am Institut für Bewegungsforschung und Bewegungsbildung (InBuB) wissenschaftlich valide Orientierungen und Beratungsleistungen für die Anwender und potenziellen Käufer (Eltern, Erzieher, Therapeuten, Lehrer, Trainer).“

Prof. Dr. Harald Lange ([lange@inbub.de](mailto:lange@inbub.de))  
[www.bewegungsinnovation.de](http://www.bewegungsinnovation.de)

„Innovative play equipment is a crucial key for child development. In this case, movement as such assumes pacemaker functions and links development-potential of various dimensions (especially emotional, cognitive, social development). In recent years, numerous appliances and motion concepts, e.g. promoting the benefits of child development in a playful and holistic way, have come onto the market.

Our work at the Institute for motion research and education movement (InBuB) provides scientifically valid guidelines and advisory services for users and potential buyers (parents, educators, therapists, teachers, coaches).“

prof Dr. Harald Lange ([lange@inbub.de](mailto:lange@inbub.de))  
[www.bewegungsinnovation.de](http://www.bewegungsinnovation.de)

Das Airtrack Modul erfüllt die REACH-Norm und garantieren die Konformität der verwendeten Materialien mit den Normen der europäischen REACH Compliance. Das Vincotte Zertifikat (getestet HP30) zeichnet die Airtrack als ein sicheres Kindersportgerät aus.

The Airtrack module fulfills the REACH standard and guarantees the compliance of the used materials with the standards of the European REACH Compliance. The Vincotte certificate honours the Airtrack as a safe children's sport apparatus.

## SiTi – Sitz-Tisch Modul

SiTi – seat table module

Art. 36-7015

MAGCON®



Set: 3 Bausteine, 1 Auflage  
set: 3 bricks, 1 layer

Das Sitz-Tisch Modul ermöglicht 4 Kindern an einem Tisch zu sitzen und diesen zum Spielen zu nutzen. Das Modul ist somit auch nützlich für die Entspannungsphase und das sitzende Spielen wird in keinen anderen Raum verlagert. Die Sitzhöhe und die Tischhöhe sind nach DIN auf die Durchschnittsgröße von Kindergartenkindern angepasst. Durch die Tischauflage kann die Tischhöhe für etwas größere Kinder auch noch verändert werden. Diese ist durch den Magnet fest mit dem Baustein verbunden. Alle Module des Konzepts sind kombinierbar, z.B. die Ausschnitte von SiTi und die Halbzylinder von HaZy passen perfekt ineinander.

The seat table module enables 8 children to sit and play at the table. The module is useful for the relaxing time but also the table-top games are not translocated into another room. Seat and table height are fitted to an average height in accordance to DIN. The layer enables an adjustable height for taller kids. The layer and the brick have a MagCon connection. All modules are combinable, e.g. the cuttings of SiTi match the half cylinders of HaZy perfectly.

## HaZy – Halbzylinder-Balance Modul

HaZy – half cylinder balance module

Art. 36-7045

MAGCON®

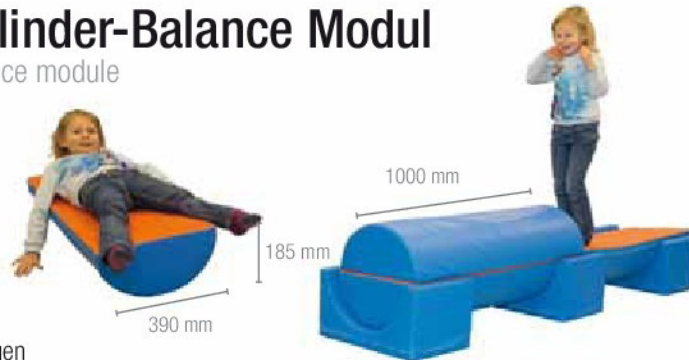

Set: 2 Halbzylinder, 2 Halterungen  
set: 2 half cylinders, 2 holders

Das Halbzylinder-Balance Modul kann zum Balancieren, zum Wippen und zum Üben der Rechts-Links-Koordination genutzt werden. Zwei Modulbausteine können zu einem Zylinder durch die „MagCon“ Verbindung zusammengefügt werden. Alle Module des Konzepts sind kombinierbar, z.B. die Ausschnitte von SiTi und die Halbzylinder von HaZy passen perfekt ineinander. Es kann in Kombination mit anderen Modulen auch als Rutsche umfunktioniert werden.

The half cylinder module is ideal to balance on it, to seesaw and to train the right left coordination of the kids. Two half cylinders can be connected with their MagCon to one full cylinder. All modules of the concept are combinable, e.g. the cuttings of SiTi match the half cylinders of HaZy perfectly. The half cylinder can be converted to a slide in combination with other modules.

## BaLa – Balance Modul

BaLa – balance module

Art. 36-7030

MAGCON®



Set: 4 Bausteine, 1 Verbindungsquader  
set: 4 bricks, 1 connection cuboid

Das Balance Modul ist durch die verschiedenen Schnitte zum Balancieren, Klettern und Bauen gut geeignet. Weiterhin bieten die unterschiedlichen Schnitte taktile Erlebnisse für Hände und Füße. Es kann in Kombination mit dem Verbindungswürfel oder anderen Modulen als Treppe genutzt werden um andere Spielwelten zu erobern. Das jeweilige Positiv-Teil passt zu einem Negativ-Teil und kann beim Zusammenstellen Stauraum sparen.

The module is good for balancing, climbing and building. The different cuts offer tactile experiences for hands and feet. It can be used as stairs in combination with the other modules to explore other gaming worlds. The positive part fits into the negative one and saves storage space.



## TuReSi – Tunnel-Regal-Sitz Modul

TuReSi – tunnel shelf seat module

Art. 36-7020



Set: 1 Röhre, 1 Kiste  
set: 1 tube, 1 box

Das Tunnel-Regal-Sitz Modul hat mehrere Funktionen. Zum einen können die Module gestapelt und als Regal verwendet werden. In den Einschüben können Spielsachen verstaut werden. Zum anderen kann aus den Röhren ein Tunnel gebaut und zum Spielen genutzt werden. Eine Röhre und ein Einsatz können als Sitz-Tisch Kombination genutzt werden. Der feste PE Schaum und der Leichtplanenstoff sorgen dafür, dass die Bausteine in ihrer Form bleiben.

This module has a lot of functions like a shelf, a tunnel or a seat table combination. The box can be used as a basket to collect toys or turned around to be used as a seat. The solid PE foam and the light tarpaulin make sure that the parts remain in good shape.

## BaBa – Ballbad

BaBa – ball pool

Art. 36-7055

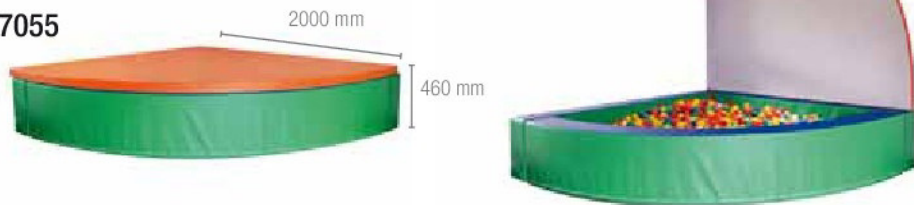

Set: 1 Ballbad, 1 Abdeckung, ohne Bälle  
set: 1 ball pool, 1 cap, without balls



empfohlene Ballmenge: 6 Kartons (3000 Bälle, siehe Seite 48)  
recommended ball quantity: 6 boxes (3000 balls, see page 48)

Das Ballbad wird natürlich vorrangig als Ballbad genutzt. Durch die Abdeckung kann aber auch eine ruhige Spielatmosphäre geschaffen werden. Ebenfalls kann es dann als Schlafplatz genutzt werden. Die Abdeckung kann weiterhin als Spielmatte genutzt werden.

To play in the ball pool is the overriding use. Now it is also possible to create a relaxing atmosphere with the cap. In addition it can be used as a bed and the cap itself can be used as a playing mat.

## LuKi – Airtrack

LuKi – Airtrack

Art. 36-7070



Abbildung ähnlich  
illustration similar

Set: 1 Airtrack, 1 Pumpe  
set: 1 Airtrack, 1 pump

Das Airtrack Modul kann als Ersatz zum Trampolin genutzt werden mit dem Vorteil, dass es wesentlich kleiner und kompakter verstaut werden kann. Durch Aufpumpen bzw. Luft ablassen bestimmt man die „Sprungkraft“. Weiterhin ist es als Schlafuntergrund nutzbar. Es wird mit einer Pumpe, aber ohne Mattensatz geliefert. Unsere MagCon Matten können Sie natürlich auch einzeln erwerben. Schauen Sie auf Seite 63.

The Airtrack module can be used as replacement for a trampoline. It is much smaller and can be easy stowed away. With inflating and releasing air you define the hardness grade and the bounce. It is possible to use the Airtrack as a bed. It will be delivered with a pump but without the mat set.

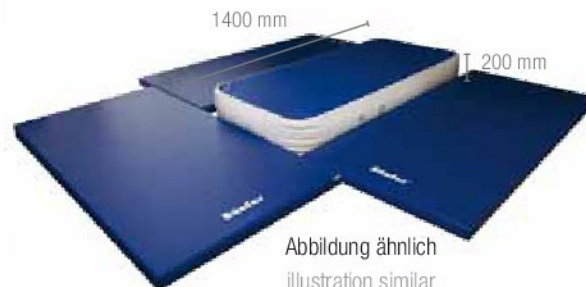
Of course our MagCon mats are available individually. Have a look on page 63.

# Zusatzmodule

additional modules



In kleinen wie in großen Räumen, kann eine Metallwand ein sinnvoller Zusatz zu den BeMo Modulen sein. Bausteine können durch ihre MagCon Verbindung (fast alle) einfach verstaut werden. Die folierte Metallwand kann aber auch zum Spielen genutzt werden, indem sie Spiele, Malvorlagen oder Übungen beinhaltet. Auch eine vollflächige Fallschutzmatte ist immer eine gute Zusatzoption. Die Anwendung ist in allen Fallbereichen (z.B. kleine Boulderwände, Deckengehänge, Sprossenwände) optimal, vor allem aber in Bereichen, in denen die Matte dauerhaft liegen bleiben kann. Bitte schauen Sie sich hierzu Seite 78 an.

A metal plate is very usefull for smaller and bigger rooms. The BeMo modules can be stowed away through their MagCon connection (nearly all of them). The plate will be coated with a foil. This can include a print with games, drawing templates or exercises. A fall protection mat for the room is always a good choice, too. Their application is under small boulder walls or maybe ceiling pendants. Please have a look on page 78.



# Kreativ-Spiel

creative play

- |    |                       |                         |
|----|-----------------------|-------------------------|
| 47 | Ballbäder             | ball pools              |
| 51 | Puzzle- & Aktivspiele | puzzle and active games |
| 58 | Schaukeln             | swings                  |
| 60 | Spielmatten           | playing mats            |



Zu unseren konzeptionell gut durchdachten Artikeln zum Thema „Kreativ-Spiel“ kamen wir nach eigenen Erforschungen und längeren Gesprächen mit Pädagogen, die uns in ihren Fachgebieten Hilfestellung leisteten. So können wir unsere Artikel mit bestem Gewissen anbieten. Denn nichts ist wichtiger als die Kinder frühzeitig in Ihren Sinnen zu schulen. Darauf basiert das Thema „Kreativ-Spiel“ auf den folgenden Seiten.

Planenstoff, Leichtplanenstoff: schwer entflammbar, phthalatfrei, urin- und schweißbeständig, speichelecht  
 Schaum: Öko-TEX zertifiziert

We created conceptual and sophisticated items under the topic of creative games. Long conversations with educators and our own research were a good support. So we can sell them with the best of our knowledge and belief. Nothing is more important than to educate the kids early with their senses. The theme creative play is based on that on the following pages.

tarpaulin, light tarpaulin: low flammability, phthalates-free, urine and sweat resistant, salivary resistant  
 foam: Oeko-TEX standard certified



Leichtplanenstoff  
light tarpaulin



Planenstoff  
tarpaulin



flammhemmend  
flame-retarding



flüssigkeitsbeständig  
fluid resistant

## Viertelkreis-Ballbad, groß

big quarter circle ball pool

Art. 96-025 (ohne Bälle, without balls)



empfohlene Ballmenge: 6 Kartons (3000 Bälle, siehe Seite 48)  
recommended ball quantity: 6 boxes (3000 balls, see page 48)

Der große Bruder unseres kleinen Viertelkreis-Ballbades ist diese Variante. Hier finden reichlich Kinder Platz, um sich auszutoben oder einfach im großen Bällemeer zu versinken.

Bezug: Leichtplanenstoff mit Klettverbindung

Kern: PU (RG 23)

Abmessungen: 2000 x 2000 x 500 mm

There is a lot of space for many children, who can run riot and take a dive into imagination.

cover: light tarpaulin with Velcro® connection

core: PU foam (volume weight 23)

measurements: : 2000 x 2000 x 500 mm

Wir haben auch eine Abdeckung für dieses Ballbad. Schauen Sie auf Seite 50.

We have a cap for this ball pool. Have a look on page 50.

## Viertelkreis-Ballbad, klein

small quarter circle ball pool

Art. 36-315 (ohne Bälle, without balls)



empfohlene Ballmenge: 4 Kartons (2000 Bälle, siehe Seite 48)  
recommended ball quantity: 4 boxes (2000 balls, see page 48)

Passend für kleine Spielecken. Ein wahrer Spielspaß auf kleinem Raum. Es ist ohne Inhalt sehr leicht zu verstauen.

Bezug: Leichtplanenstoff mit Klettverbindung

Kern: PU (RG 23)

Abmessungen: 1950 x 1950 x 300 mm

A ball pool for facilities with lack of space. It fits in every corner (without contents).

cover: light tarpaulin with Velcro® connection

core: PU foam (volume weight 23)

measurements: 1950 x 1950 x 300 mm

## BIG Rutsche

BIG slide

Art. 40-3202



Diese Rutsche passt auf alle Ballbäder. Denn sie lässt sich im Neigungswinkel verstellen und ist auch etwas länger.

This slide suits for each ball pool. It is adjustable in inclination and longer than other slides.

Geeignet für Artikel (suitable for items):

96-025, 96-010, 36-315, 36-311

## Bälle

balls

Art. 96-050

Art. 96-050-bl

Art. 96-050-ro

Art. 96-050-ge

Art. 96-050-gr

Art. 96-052

bunt (coloured mixed)

blau (blue)

rot (red)

gelb (yellow)

grün (green)

transparent (transparent)

Sondergröße (special size) 75 mm: Art. 96-051 bunt (coloured mixed)

Das Wichtigste bei einem Ballbad ist die Füllung. Pro Karton erhalten Sie 500 Qualitätsbälle. Balldurchmesser: 60 mm

The most important thing for a ball pool is the filling.

1 box contains 500 balls. Diameter of each ball: 60 mm



Alle Ballbäder sind mit einem klettbaren Boden ausgestattet.  
Die Ballbäder werden standardmäßig ohne Rutschen und Bälle geliefert.

All ball pools are equipped with a ground floor made of tarpaulin and Velcro®.  
The ball pools come without any slides or balls.

## Viereck-Ballbad

square ball pool

Art. 96-010 (ohne Bälle, without balls)



## Treppenrutsche groß

big stairway slide

Art. 36-146-12



empfohlene Ballmenge: 8 Kartons (4000 Bälle)  
recommended ball quantity: 8 boxes (4000 balls)

Wenn's mal etwas mehr sein darf. Ein großes Ballbad welches kaum noch Wünsche offen lässt.

Bezug: Leichtplanenstoff mit Klettverbindung

Kern: PU (RG 23)

Anything else? Big ball pool leaves nothing to be desired.

cover: light tarpaulin with Velcro® connection

core: PU foam (volume weight 23)

Die Treppenrutsche passend für das Viereck-Ballbad (96-010).

Bezug: Leichtplanenstoff

Kern: PU (RG 25)

Abmessungen: 1720 x 600 x 650 mm, Ausschnitthöhe: 500 mm

The big stairway slide fits with square ball pool (96-010)

cover: light tarpaulin

core: PU foam (volume weight 25)

measurements: 1720 x 600 x 650 mm, cutout height: 500 mm

## Regenbogen-Ballbad

rainbow ball pool

Art. 36-311 (ohne Bälle, without balls)



## Treppenrutsche klein

small stairway slide

Art. 36-132



empfohlene Ballmenge: 4 Kartons (2000 Bälle)  
recommended ball quantity: 4 boxes (2000 balls)

So bunt wie der Regenbogen ist dieses süße kleine Ballbad. Ideal für Orte mit nicht so viel Platz. Mit einer integrierbaren Treppenrutsche macht diese Ballbad-Variante nochmal so viel Spaß.

Bezug: Leichtplanenstoff mit Klettverbindung

Kern: PU (RG 23)

As colourful as a rainbow. The ball pool for facilities with lack of space. A stairway-slide is available in addition and makes fun.

cover: light tarpaulin with Velcro® connection

core: PU foam (volume weight 23)

Die Treppenrutsche passend für das Regenbogen-Ballbad (36-311).

Bezug: Leichtplanenstoff, Kern: PU (RG 25)

Abmessungen: 1300 x 600 x 500 mm, Ausschnitthöhe: 370 mm

The small stairway slide fits with square ball pool (96-010)

cover: light tarpaulin, core: PU foam (volume weight 25)

measurements: 1300 x 600 x 500 mm, cutout height: 370 mm

## Ballbad abgedeckt

ball pool with cap

Art. 36-7055 (ohne Bälle, without balls)

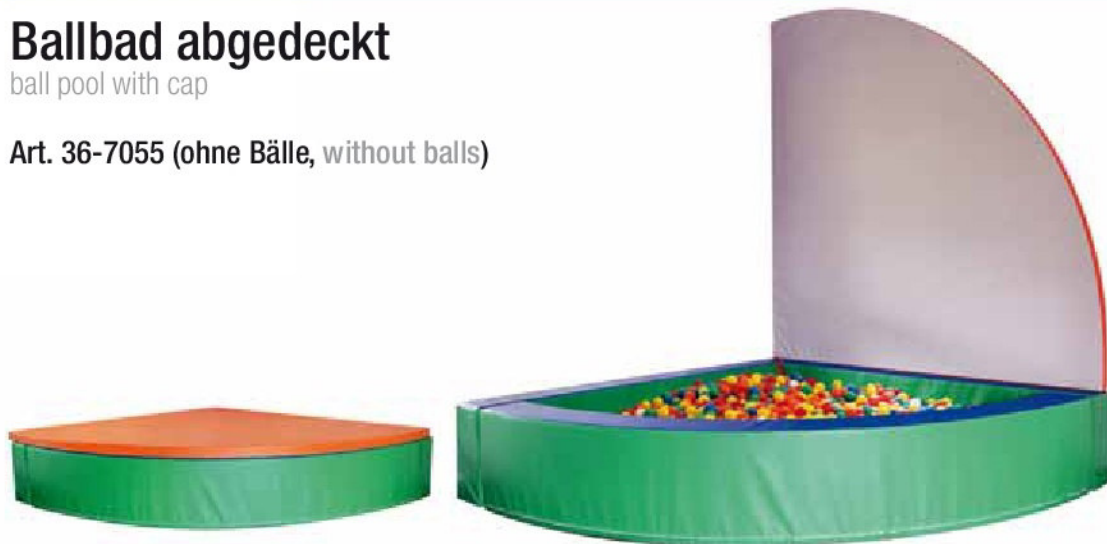

empfohlene Ballmenge: 6 Kartons (3000 Bälle, siehe Seite 48)  
recommended ball quantity: 6 boxes (3000 balls, see page 48)

Das Ballbad wird natürlich vorrangig als Ballbad genutzt. Durch die Abdeckung kann aber auch eine ruhige Spielatmosphäre geschaffen werden. Ebenfalls kann es dann als Schlafplatz genutzt werden. Die Abdeckung kann weiterhin als Spielmatte genutzt werden. Maße: 2000 x 2000 x 460 mm

To play in the ball pool is the overriding use. Now it is also possible to create a relaxing atmosphere with the cap. In addition it can be used as a bed and the cap itself can be used as a playing mat. measurements: 2000 x 2000 x 460 mm

Die Abdeckung ist auch einzeln erhältlich und ebenfalls mit Art. 96-025 (Seite 47) kompatibel. Die Standardfarbe ist Orange. Weitere Farben sind auf Anfrage erhältlich. The cap is available individually. It is also compatible with item nr. 96-025 (page 47). The standard colour is orange. There are more colours available on request.

### Abdeckung (cap)

Art. 36-7055-10

2000 x 2000 x 60 mm

Art. 36-7055-20

1800 x 1800 x 60 mm

## Riesenmatte

giant mat

auch in diesen Farben erhältlich:  
also available with these colours:

HG GR HB BL RO OR GE



Diese Matte lädt zum Spielen, Toben, Entspannen und Entdecken ein. Legt man andere Bausteine unter die Matte, entsteht eine Erlebniswelt. Die Matte schmiegt sich an die Bausteine an.

Bezug - oben und seitlich: Leichtplanenstoff, unten: Antirutsch-Stoff, Reißverschluss, Kern: PU (RG 25/40)

This mat invites to play, to cavort, to relax and to explore. A world of experiences comes up, if you put foam bricks under the mat. The mat clings to the bricks.  
cover: light tarpaulin, bottom anti-slip material, zipper,  
core: PU foam (volume weight 25/40)

### Art.

93-1000-Farbe (colour)

2500 x 2900 x 40 mm

93-1100-Farbe (colour)

3000 x 2900 x 40 mm

93-1200-Farbe (colour)

3500 x 2900 x 40 mm

93-1300-Farbe (colour)

4000 x 2900 x 40 mm

93-1400-Farbe (colour)

4500 x 2900 x 40 mm

## Bänfers Hüppeding

Bänfers Hüppeding

Art. 96-080	Set	Ø 1000 mm
Art. 96-081	Set	Ø 1500 mm
Art. 96-082	Set	Ø 2000 mm
Art. 96-086	Doppelhubpumpe double stroke pump	
Art. 96-087	elektrische Pumpe electric pump	



Ein wahrlich platzsparendes Kindertrampolin, welches den Kindern selbst im Wasser oder Schnee als Insel oder Boot Spaß bereitet. Eine Doppelhubpumpe wird mitgeliefert.

A space-saving trampoline which is also usable in water or at snow. The double stroke pump is included.



Nicht als Schwimmhilfe geeignet.  
Unsuitable as buoyancy aid.

## Wut-Keule

anger club

Art. 36-541



Integrierter Griff.  
Integrated handle piece.



Kinder müssen Angst, Stress und Furcht verarbeiten können. Diese Gefühle beherrscht bzw. vergisst man durch das Spiel mit der Wut-Keule. Sie ist komplett aus Schaumstoff verarbeitet und führt somit zu keinen Schmerzen. So können zwei Kinder sich gegenseitig duellieren und dabei mächtig viel Spaß haben. Eine Therapie durch Aggressionsabbau ist so gut wie garantiert.

Bezug: Baumwolle

Kern: fester Schaumstoff mit Griffstück

Abmessungen: ca. 600 x 170 x 160 mm

Children should treat their fear, stress and dread. While playing with the anger club they will forget or control tear feelings and will have fun. It is made of foam. Do not believe that anger club will lead to violence, it is rather a safety valve to let out aggression.

cover: cotton

core: solid foam with a handle piece

measurements: approx. 600 x 170 x 160 mm



## Trapezelement

trapeze element

Art. 34-1030-Farbe (colour)



Die Trapezelemente werden durch eine Klettverbindung miteinander verbunden.  
Bezug: Leichtplanenstoff, farbig  
Kern: PU (RG 25)

The trapeze elements are connected by Velcro® fastener.  
cover: light tarpaulin, coloured  
core: PU foam (volume weight 25)

auch in diesen Farben erhältlich:  
also available with these colours:



## Achteckkraupe

octagonal caterpillar

Art. 36-950



Die Achteckkraupe besteht aus 8 Einzelementen, die mit Klettverbindungen zu einer Balancier-Raupe zusammengelegt werden können.  
Bezug: Leichtplanenstoff, farbig  
Kern: PU (RG 23)

The octagonal caterpillar consists of 8 single elements with Velcro® system. It can be combined to a balancing caterpillar.  
cover: light tarpaulin, coloured  
core: PU foam (volume weight 23)

## Balancierbalkenwürfel

balance beam cube

Art. 34-1050-16



mittelhart, mittelweich, hart, weich



Die Kerne der einzelnen Elemente des Würfels haben unterschiedlich Härtegrade. Hier können die Kinder ihr Balance testen und trainieren.

Bezug: Leichtplanenstoff, farbig  
Kern: PU  
4 Trapeze (480 x 480 x 240 mm)  
1 Zylinder (480 x 240 x 240 mm)  
1 Bezug als Sitzwürfel (Orange)

The cores of the single elements have a different degree of hardness. The kids can test and train their balance skills.

cover: light tarpaulin, coloured  
core: PU foam  
4 trapezes (480 x 480 x 240 mm)  
1 cylinder (480 x 240 x 240mm)  
1 cover for cube seat (orange)

## Motorik-Ball

motor skills ball

Art. 96-061-16



Im Vordergrund steht hier die Schulung des Gleichgewichtsinnes und somit die Schulung der Motorik. Weiterhin ist der Motorik-Ball eine gute Unterstützung bei Konzentrations- und Koordinationsübungen.

Bezug: Leichtplanenstoff, Gummiblase

Abmessungen: Ø 900 mm

Priority is given to the sense of balance and motor function. In addition the motor skills ball is a good support for concentration and coordination exercises.

cover: light tarpaulin, rubber bubble

measurements: Ø 900 mm

## Spieltonne

playing drum

Art. 34-1005-16



Die Spieltonne eignet sich super zum Turnen, Spielen und für Gymnastikübungen.

Bezug: Leichtplanenstoff, farbig

Kern: PU (Rg 30)

Höhe: 1000 mm, Innen: Ø 430 mm, Außen: Ø 700 mm

The playing drum is perfect for gymnastics, playing and gymnastic exercises.

cover: light tarpaulin, coloured

core: PU foam (volume weight 30)

height: 1000 mm; inside: Ø 430 mm, outside: Ø 700 mm

## Spielröhre mit Innenzylinder

playing tube with interior cylinder

Art. 34-076-12

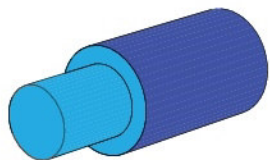

Die Spielröhre eignet sich hervorragend zum Spielen und zur Physiotherapie.

Bezug: Leichtplanenstoff, farbig

Kern: PU (RG 25)

Höhe: 1000 mm, Innen: Ø 400 mm, Außen: Ø 600 mm

The playing tube is excellent for playing and physiotherapy.

cover: light tarpaulin, coloured

core: PU foam (volume weight 25)

height: 1000 mm; inside: Ø 400 mm, outside: Ø 600 mm

## Krabbelwalze

crawl cylinder

Art. 96-076



Bezug: Vinyl-Planenstoff, farbig  
Kern: PU (RG 18)  
Innen: Umfang: 2800 mm; Breite: 450 mm

cover: vinyl tarpaulin, coloured  
core: PU foam (volume weight 18)  
inside: circumference: 2800 mm; width: 450 mm

## Rollbretter

scooters

1 Art. 96-1006

2 Art. 96-1000



Die Bänfer Rollbretter gewährleisten eine leichte Handhabung und haben ausserdem einen tiefen Schwerpunkt, was sie kippstabil macht. Das Rollbrett mit Griffmulden bietet Schutz der Hände durch die Griffmulden. Das zweite Rollbrett ist gepolstert. Sie sind mit robusten Vollgummireifen ausgestattet.

Abmessungen 1: 510 x 350 x 110 mm, Abmessungen 2: 600 x 450 x 100 mm

The Bänfer scooters are easy to handle. In addition they have a low centre and they are tilt-proof. The scooter with recessed grips protects the hands. The other one is upholstered. They are equipped with solid rubber tyres.

measurements 1: 510 x 350 x 110 mm, measurements 2: 600 x 450 x 100 mm

## Treppenwippe

stair rocker

Art. 34-120-12

Art. 34-120-12-01

Art. 34-120-12-02

Set  
set

kleine Treppe (3 Stufen)

small stairs (3 steps)

große Treppe (4 Stufen)

big stairs (4 steps)



Achtung, jetzt wird's wackelig. Denn mit der Treppenwippe geht es treppauf und treppab zugleich.

Bezug: Leichtplanenstoff, Unterseite TMST, Kern: PU (RG 25)

Attention, it is shaky! With the stair rocker it goes up and down at the same time.  
cover: light tarpaulin, bottom textured tarpaulin, core: PU foam (volume weight 25)



## Kinder-Klappsessel

kids folding chair

Art. 29-7300



Ein großartiger Platz für die Lese- und Ruhecke. Der Entspannungssessel lässt sich sehr schnell von den Kindern auf- und abbauen.

Bezug: Leichtplanenstoff

Kern: PU (RG 25)

Abmessungen zugeklappt: 470 x 360 x 310 mm

Abmessungen aufgeklappt: 760 x 360 x 468 mm

This chair is great for a reading and quiet corner. The relaxation chair can be assembled and disassembled by the children very quickly.

cover: light tarpaulin

core: PU foam (volume weight 25)

measurements disassembled: 470 x 360 x 310 mm

measurements assembled: 760 x 360 x 468 mm



## Geo-Max

Geo-Max

Art. LO-1000

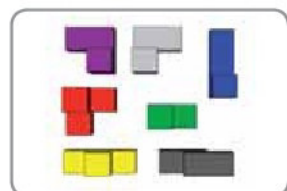

27 Würfel sind hier zu 7 spektralfarbigen, unterschiedlich geformten Bauelementen zusammengefügt. Aus diesen Elementen lassen sich viele schöne Figuren bauen. Der Bau des kompletten Würfels ist eine echte Herausforderung. Der Geo-Max ist eine Bewegungsbaustelle, bei der das Auf- und Abbauen der verschiedenen Formen nicht nur Spaß und Bewegung bringt, sondern darüber hinaus ganz nebenbei das Gruppenverhalten der Kinder verbessern wird. Zusätzlich ist der Geo-Max auch für Erwachsene für Gruppentherapien gut geeignet.

Bezug: Leichtplanenstoff, Kern: PU 25

Abmessungen: 900 x 900 x 900 mm

27 cubes are joined together in different ways to make 7 different construction components in rainbow colours. You can use the components to make all sorts of wonderful shapes. Putting them all together to make the whole cube is a real teaser. Geo-Max gets the builders moving: putting the shapes together and taking them apart involves fun and movement, but an extra bonus is the boost it gives to the children's interactive skills. In addition the Geo-Max is good for adults in group therapy.

cover: light tarpaulin, core: PU 25

measurements: 900 x 900 x 900 mm

## Haus-Puzzle

house puzzle

Art. 36-900



„Ich hab´ ein Haus, ein kunterbuntes Haus, ...“ sang schon eine bekannte Kinderbuchfigur. Doch mit diesem Haus-Puzzle haben die Kinder wirklich ein kunterbuntes Haus und können es selbst aufbauen. Durch die integrierten Fenster (in verschiedenen Formen) lernen sie ausserdem noch Farben und Formen kennen. Ein tolles Spiel- und Lernerlebnis.

Bezug: Leichtplanenstoff

Kern: PU (RG 25)

Abmessungen: 1200 x 1200 x 1200 mm

“I have a house, a colourful house, ...” sang already a famous children's book character. With this puzzle house your children have a motley house and they can set it up on their own. They learn about colours and forms in the same time. A great gaming and learning experience.

cover: light tarpaulin, coloured

core: PU foam (volume weight 25)

measurements: 1200 x 1200 x 1200 mm

## Tunnel Long

tunnel long

Art. 36-400



Hier kann man sich super verstecken und ausruhen und wenn die Kinder toben wollen ist der “Tunnel Long” auch dafür gerüstet. Mit einem Handgriff ist dieser in eine große Tum- und Spielfläche verwandelt.

Bestehend aus:

1 Matte 2000 x 2000 x 100 mm und 1 Matte 2000 x 1000 x 100 mm

Bezug: Leichtplanenstoff (rot, gelb, blau), Reißverschluss & Klettaschen

Kern: PU (RG 30)

Hiding and relaxing is possible here. You also can bluster at the mats because with one hand movement only you will obtain a big play area.

consisting of:

1 mat 2000 x 2000 x 100 mm and 1 mat 2000 x 1000 x 100 mm

cover: light tarpaulin (red, yellow, blue), zipper and Velcro® tabs

core: PU foam (volume weight 30)

## Karlchen das Krokodil

Karl the crocodile

Art. 34-1150



Karlchen das Krokodil kommt direkt aus dem Nil und isst gerne Spaghetti mit Spinat, denn ohne Spinat wäre Karlchen nicht so groß und stark geworden. Er begleitet seine Freunde gerne bei ihren Abenteuern und beschützt sie mit seinen scharfen Zähnen. Wenn für Karlchen mal kein Platz ist, lässt er sich leicht verstauen.

Bezug: PVC-freie Hülle mit PU-Beschichtung

Kern: PU (RG 25)

Abmessungen: ca. 1650 x 200 x 1150 mm

Karlchen comes from the Nil and loves to eat spaghetti and spinach. Without spinach Karlchen would not be so big and powerful. Karlchen accompanies and guards his friends by their adventures. Should you not have enough space you can stow the elements very easily.

cover: free of PVC with PU coating

core: PU foam (volume weight 25)

measurements: approx. 1650 x 200 x 1150 mm

## Elfi die Ente

Elfi the duck

Art. 34-1140



Elfi ist eine kleine süße Ente, die sich auf neue Freunde freut, mit denen sie die Welt erkunden kann. Denn Elfi ist eine kleine Weltenbummlerin.

Elfi besteht aus 4 Teilen und lässt sich superleicht verstauen.

Bezug: PVC-freie Hülle mit PU-Beschichtung

Kern: PU (RG 25)

Abmessungen: ca. 600 x 570 x 200 mm

Elfi is a small sweet duck, which loves to make new friends to explorer the world. She is a globetrotter. Elfi consists of 4 pieces and is easy to stow.

cover: free of PVC with PU coating

core: PU foam (volume weight 25)

measurements: approx. 600 x 570 x 200 mm

## Sitzschaukel

seat swing

Art. 29-6010



Seilende  
rope end



2-Punkt-Aufhängung  
2-point suspension

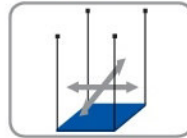

4-Punkt-Aufhängung  
4-point suspension

Diese speziell für Kinder ab 2 Jahre entwickelte Schaukel bietet extrem viel Halt. Kinder fühlen sich vom ersten Moment an sicher.

Bezug: Planenstoff

Kern: Holz mit Verbundschaumstoff

Abmessungen: ca. 650 x 350 x 50 mm

Specially for children from 2 years. From the first moment they feel confident, because of the good hold.

cover: tarpaulin

core: wood with a composite foam

measurements: approx. 650 x 350 x 50 mm

## Rundschaukel

round swing

Art. 29-6025



Seilende  
rope end

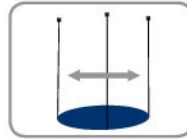

3-Punkt-Aufhängung  
3-point suspension



1-Punkt-Aufhängung (nur  
mit Wirbel möglich)  
1-point suspension (only  
possible with a vortex)

Die Schaukel ist ideal zur Förderung des Gleichgewichtssinnes

Bezug: Planenstoff

Kern: Holz mit Verbundschaumstoff

Abmessungen: Ø 1000 x 60 mm

The swing is ideal for training of the equilibrium.

cover: tarpaulin

core: wood with a composite foam

measurements: Ø 1000 x 60 mm



Alle Schaukelanlagen sind für Raumhöhen von bis zu 3 Meter konzipiert und besitzen eine integrierte Höhenverstellung. Freies Schaukeln fördert die motorischen Fähigkeiten der Kinder. Das zulässige Maximalgewicht für die Schaukeln beträgt 120 kg.

All swings are suitable for rooms up to 3 meters and the height adjustment is integrated. Swinging stimulates skill of children coordination. The permissible maximum weight is 120 kg.



## Viereckschaukel

rectangle swing

Art. 29-6020



Seilende  
rope end



2-Punkt-Aufhängung  
2-point suspension

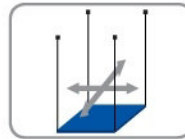

4-Punkt-Aufhängung  
4-point suspension



1-Punkt-Aufhängung (nur  
mit Wirbel möglich)  
1-point suspension (only  
possible with a vortex)

Ein Schaukelerlebnis mit jeder Menge Spaß in jeder Ecke. Durch die Schaukelkonstruktion haben gleich mehrere Kinder viel Platz auf der Schaukel. So wird zugleich das "Zusammenspielen" gefördert.

Für motorische Übungen und Schulungen des Gleichgewichtsorgans finden Sie hier die besten Voraussetzungen. Ein Muss für jedes Schulungszentrum.

Bezug: Planenstoff

Kern: Holz mit Verbundschaumstoff

Abmessungen: ca. 1000 x 1000 x 60 mm

Enjoy the experience to dandle with this swing. There is enough space for more than one child. Social behaviours are encouraged with this swing. The swing is perfect for training motor skills and the equilibrium organ. An absolut must for every training centre.

cover: tarpaulin

core: wood with a composite foam

measurements: approx. 1000 x 1000 x 60 mm

## Pferdeschaukel

horse swing

Art. 29-6030



Seilende  
rope end



2-Punkt-Aufhängung  
2-point suspension

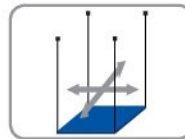

4-Punkt-Aufhängung  
4-point suspension

Wer will als Kind nicht gerne auf einem Pferd reiten? Hier simuliert die Schaukel das Pferd. Ein tolles und sicheres Schaukelgefühl. Alternativ kann das „Pferd“ auch mit einem Sattel ausgestattet werden.

Bezug: Planenstoff

Kern: Holz mit Verbundschaumstoff

Abmessungen: ca. 750 x 320 x 60 mm

Which child will not go riding? This swing may be the horse. In addition you could saddle the horse.

cover: tarpaulin

core: wood with a composite foam

measurements: approx. 750 x 320 x 60 mm

## Pferdesattel

horse saddle

Art. 29-6040



Um das „richtige“ Gefühl vom Reiten zu bekommen, sollte man sein Pferd satteln.

For the right feeling you need the saddle.



# Spielmatten mit Kindermotiven

playing mats with children's motifs



Auf diesen Matten macht das Spielen, Turnen und Rumlümmeln noch mehr Spaß als auf einer gewöhnlichen Turnmatte.

Kern: VB 80

Bezug: Planenstoff, unten Turnmattenstoff (auf Wunsch mit Klettecken)

Abmessungen: ca. 1500 x 1000 x 60 mm

Gaming, gymnastics and lounging makes more fun on this mats than on common mats.

core: composite foam 80

cover: tarpaulin, bottom textured tarpaulin (upon request with Velcro® corners)

measurements: approx. 1500 x 1000 x 60 mm

auch in diesen Farben erhältlich:

also available with these colours:



- |   |                                    |   |
|---|------------------------------------|---|
| 1 | <b>Art. 15-3000-Farbe (colour)</b> | Motiv: Springseil<br>motif: skipping rope |
| 2 | <b>Art. 15-4000-Farbe (colour)</b> | Motiv: Liegestütze<br>motif: push-ups     |
| 3 | <b>Art. 15-5000-Farbe (colour)</b> | Motiv: Bocksprung<br>motif: leap-frog     |
| 4 | <b>Art. 15-6000-Farbe (colour)</b> | Motiv: Jonglieren<br>motif: juggling      |

Auf Wunsch bekommen Sie die Matten mit Klettecken zum Erstellen von großen Flächen.

Upon request you get the mats with Velcro® corners to create large areas.

Verbundschaum-Kern  
composite foam core



# Hüpfekästchen

hopscotch

Art. 01-5600-Farbe (colour)



Verbundschaum-Kern  
composite foam core



Kennen Sie das?

Es regnet und die Kinder wollen unbedingt mit Straßenkreide malen und spielen, zum Beispiel Hüpfekästchen. Dieses Spiel lässt sich jetzt ohne weiteres auch im Haus spielen und dazu ist es noch sicher. Denn der Aufdruck ist auf einer Tummatte. So gibt es keine Verletzungsgefahr bei Stürzen.

Kern: VB 80, Bezug: Planenstoff, unten Turnmattenstoff (auf Wunsch mit Klettecken)  
Abmessungen: 2000 x 1000 x 60 mm

Do you know that? It is raining and children would like to play with chalks on the street, for example hopscotch. Now it is playable at home. The imprint is on a mat therefore there is no risk of injuries.

core: composite foam 80, cover: tarpaulin, bottom textured tarpaulin (upon request with Velcro® corners)

measurements: 2000 x 1000 x 60 mm

auch in diesen Farben erhältlich:

also available with these colours:



# Weitsprungmatte

long jump mat

Art. 01-5700-Farbe (colour)

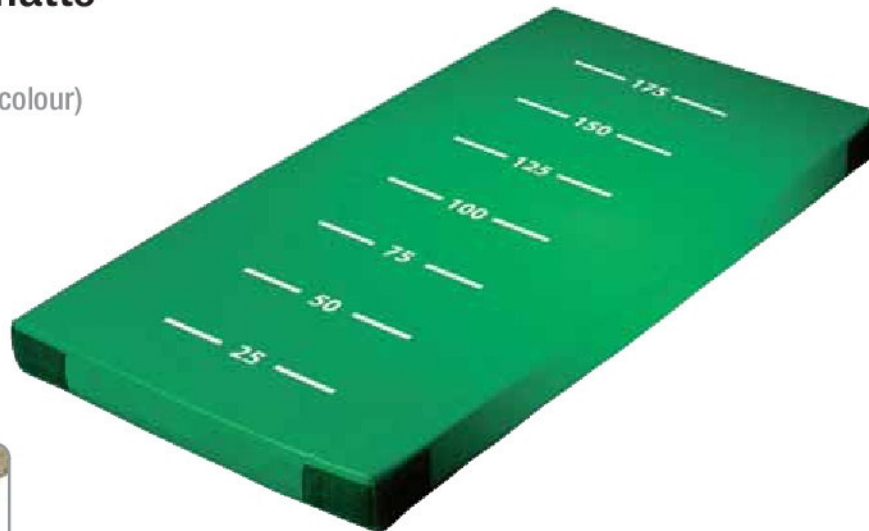

Verbundschaum-Kern  
composite foam core



Wer kann am weitesten springen? Und wie weit ist das Kind gesprungen? Hier die Antwort. Auf der Tummatte ist eine Größenskala aufgebracht. So kann diese Turnmatte super als Wettkampfmatte oder Spielmatte in vielen anderen Bereichen verwendet werden. Um besser anlaufen und abspringen zu können, empfehlen wir, eine weitere Matte vor die Weitsprungmatte zu legen.

Kern: VB 80, Bezug: Planenstoff, unten Turnmattenstoff (auf Wunsch mit Klettecken)  
Abmessungen: 2000 x 1000 x 60 mm

Who makes the longest jump? Here is the answer. The imprint on the mat contains a size scale, usable for playing and competitions. We recommend an additional mat in front of the long jump mat to start and jump better.

core: composite foam 80, cover: tarpaulin, bottom textured tarpaulin (upon request with Velcro® corners), measurements: 2000 x 1000 x 60 mm

auch in diesen Farben erhältlich:

also available with these colours:



# Turnen, Fall- & Prallschutz

gymnastics, paddings

63	Turnmatten	gym mats
70	Weichböden	safety mats
72	Fallschutzmatten und Systeme	protection mats and systems
80	Schutzpolster	protection pads
84	Timeout-Räume	time out rooms
85	Snøezelenräume	Snøezelen rooms
86	Wandmatten	wall mats

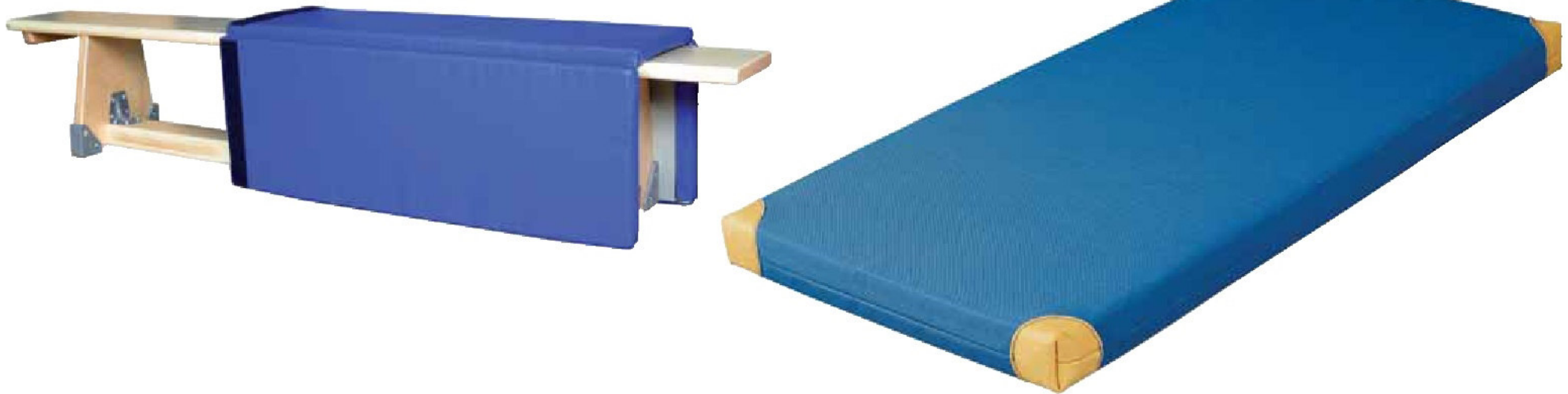

Sicherheit ist unser höchstes Ziel ...

Wir haben uns zum Ziel gesetzt alle Einsatzbereiche im Spiel- und Freizeitbereich (Indoor) sowie innovative Produkte gezielt auf Fallschutz zu untersuchen und entsprechende Lösungen aufzuzeigen. Unfallverhütung und somit Sicherheit für Kinder sollte eines der wichtigsten Themen sein. Kinder sind neugierig und je kleiner die Kinder sind, umso wissbegieriger sind sie. Kinder sollen ihre Welt entdecken und zwar sicher! Wir entwickeln Matten, Weichböden, Fallschutz, Prallschutz und vieles mehr. Überzeugen Sie sich auf den nächsten Seiten von unserer Vielfalt.

Safety is our highest aim ...

We are targeting to study all areas of play and leisure for fall protection and coming up with solutions. One of our most important topics is accident prevention and safety for the kids. Kids are curious and the younger ones even more. They should explore their world but safe. We develop mats, landing mats, fall protection, paddings and much more. Just have look on our next pages and convince yourself.

# Super-Leichtturnmatte mit MagCon

super lightweight exercise mat with MagCon



auch in diesen Farben erhältlich:  
also available with these colours:



MagCon ist die neue patentierte Verbindung von Matten mit Magnetstreifen. Die lästige Verschmutzung, welche bei Klettecken ab einer gewissen Zeit üblich ist, entfällt. Die Magnete verschwinden optimal unter dem Planenstoff und es entstehen keine gefährlichen Ecken und Kanten. Durch die Magnetverbindung können die Matten in jeder Lage verbunden werden (z.B. lange Seite mit kurzer Seite etc.).

Kern: PE Schaum, Bezug - oben und seitlich: Planenstoff, unten: Turnmattenstoff

MagCon is the new patented connection of mats with magnetic strips. The advantage is that there is no dirtying of the usual Velcro® what is common after a certain time of use. The magnets are hidden under the sleeve and there are no hazardous comers or edges. Because of the magnetical connection it is possible to connect the mats in all positions (e.g. long side with short side etc.).

core: PE foam, cover - top and sides: tarpaulin, bottom: textured tarpaulin

15-1000V-MC-Farbe	6,5 kg	1.500 x 1.000 x 60 mm
15-1100V-MC-Farbe	7,0 kg	1.500 x 1.000 x 80 mm
15-1200V-MC-Farbe	8,5 kg	2.000 x 1.000 x 60 mm
15-1300V-MC-Farbe	9,0 kg	2.000 x 1.000 x 80 mm
15-1400V-MC-Farbe	9,5 kg	2.000 x 1.250 x 60 mm
15-1500V-MC-Farbe	10,5 kg	2.000 x 1.250 x 80 mm

PE-Kern  
PE foam core



# Gerätturnmatte Standard

apparatus exercise mat standard

auch in diesen Farben erhältlich:  
also available with these colours:



Verbundschaum-Kern  
composite foam core



Kern: VB 120 (Höhe: 60 mm), VB 100 (Höhe 80 mm),  
mit Kaschierung  
Bezug: Turnmattenstoff

core: composite foam 120 (height: 60 mm), composite foam 100  
(height: 80 mm), laminated  
cover: textured tarpaulin

ohne Besatz  
without extras

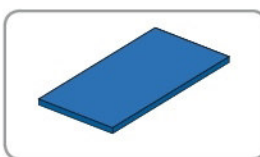

mit Klettecken  
with Velcro® corners

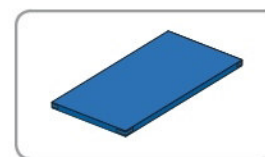

mit Lederecken  
with leather corners

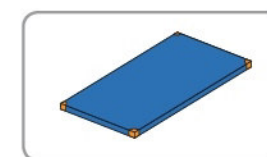

mit Lederecken und Trage-  
schlaufen  
with leather corners and loops

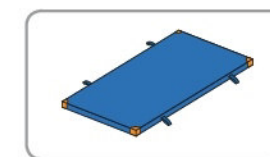

Art. 01-2200	1500 x 1000 x 60 mm	14,0 kg
ist nach DIN EN 12503-1 Typ 3 gefertigt	1500 x 1000 x 80 mm	14,5 kg
item nr. 01-2200 is produced in accordance to DIN EN 12503 typ 3	2000 x 1000 x 60 mm	18,0 kg
	2000 x 1000 x 80 mm	19,0 kg
	2000 x 1250 x 60 mm	22,0 kg
	2000 x 1250 x 80 mm	24,0 kg

01-2000-Farbe (colour)	01-2000K-Farbe (colour)	01-2000L-Farbe (colour)	01-2000LT-Farbe (colour)
01-1100-Farbe (colour)	01-1100K-Farbe (colour)	01-1100L-Farbe (colour)	01-1100LT-Farbe (colour)
01-2200-Farbe (colour)	01-2200K-Farbe (colour)	01-2200L-Farbe (colour)	01-2200LT-Farbe (colour)
01-1300-Farbe (colour)	01-1300K-Farbe (colour)	01-1300L-Farbe (colour)	01-1300LT-Farbe (colour)
01-2400-Farbe (colour)	01-2400K-Farbe (colour)	01-2400L-Farbe (colour)	01-2400LT-Farbe (colour)
01-1500-Farbe (colour)	01-1500K-Farbe (colour)	01-1500L-Farbe (colour)	01-1500LT-Farbe (colour)

# Gerätturnmatte Leicht Exklusiv

apparatus exercise mat light exclusive



Spezialschaum-Kern  
special foam core



auch in diesen Farben  
erhältlich:  
also available with these  
colours:



1500 x 1000 x 60 mm	7,0 kg
2000 x 1000 x 60 mm	9,0 kg
2000 x 1250 x 60 mm	10,0 kg



Die Lightmatte ist eine neuartige, extra leichte Gerätturnmatte mit den Eigenschaften nach DIN und EN 12503-1. Der Spezialschaumstoffkern hat die gleichen Eigenschaften wie Verbundschaum RG 120 ist aber 50% leichter. Die Hülle ist aus profiliertem Tummattenstoff gefertigt, der speziell rutschhemmend ist.

The light mat is a new extra light apparatus mat with damping characteristic accordingly DIN and EN 12503-1. The special foam core has same characteristics as composite foam RG 120 but it is 50% lighter. The cover is manufactured of textured tarpaulin which is slip resistant.

ohne Besatz  
without extras

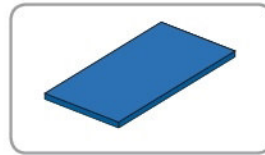

01-2000-light-Farbe (colour)  
01-2200-light-Farbe (colour)  
01-2400-light-Farbe (colour)

mit Klettecken  
with Velcro® corners

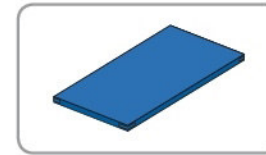

01-2000K-light-Farbe (colour)  
01-2200K-light-Farbe (colour)  
01-2400K-light-Farbe (colour)

mit Lederecken  
with leather corners

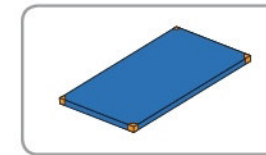

01-2000L-light-Farbe (colour)  
01-2200L-light-Farbe (colour)  
01-2400L-light-Farbe (colour)

mit Lederecken und Trage-  
schlaufen  
with leather corners and loops

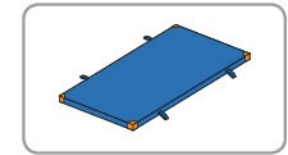

01-2000LT-light-Farbe (colour)  
01-2200LT-light-Farbe (colour)  
01-2400LT-light-Farbe (colour)

# Gerätturnmatte WEBO

apparatus exercise mat WEBO



Verbundschaum-Kern  
composite foam core



1500 x 1000 x 60 mm	14,0 kg
1500 x 1000 x 80 mm	14,5 kg
2000 x 1000 x 60 mm	18,0 kg
2000 x 1000 x 80 mm	19,0 kg
2000 x 1250 x 60 mm	22,0 kg
2000 x 1250 x 80 mm	24,0 kg

Die Gerätturnmatte WEBO ist eine preiswerte Alternative.  
Kern: VB 120 (Höhe: 60 mm), VB 100 (Höhe 80 mm),  
unkaschiert, Bezug: Tummattenstoff

The apparatus exercise mat WEBO is an affordable alternative.  
core: composite foam 120 (height: 60 mm), composite foam 100  
non-laminated, cover: textured tarpaulin

ohne Besatz  
without extras

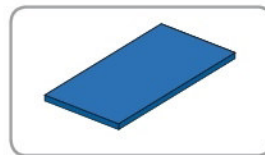

01-2000W  
01-1100W  
01-2200W  
01-1300W  
01-2400W  
01-1500W

mit Klettecken  
with Velcro® corners

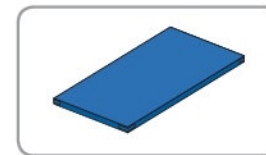

01-2000WK  
01-1100WK  
01-2200WK  
01-1300WK  
01-2400WK  
01-1500WK

mit Lederecken  
with leather corners

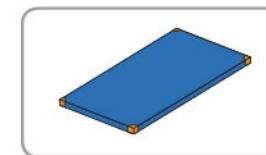

01-2000WL  
01-1100WL  
01-2200WL  
01-1300WL  
01-2400WL  
01-1500WL

mit Lederecken und Trage-  
schlaufen  
with leather corners and loops

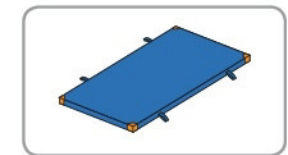

01-2000WLT  
01-1100WLT  
01-2200WLT  
01-1300WLT  
01-2400WLT  
01-1500WLT

# Leichtturnmatte

lightweight exercise mat



Verbundschaum-Kern  
composite foam core



auch in diesen Farben  
erhältlich:

also available with these  
colours:



1500 x 1000 x 60 mm	10,0 kg
1500 x 1000 x 80 mm	12,0 kg
2000 x 1000 x 60 mm	13,5 kg
2000 x 1000 x 80 mm	17,0 kg

Diese Matte ist für Schul- und Vereinsport gut geeignet. Das Einsatzgebiet bestimmt den Kern einer Matte. Die Leichtturnmatte ist für Bodenübungen geeignet.

Kern: VB 80, mit Kaschierung, Bezug: Turnmattenstoff

The mat is suitable for school and association sports. The core of a mat determines its field of application. The lightweight mat is suitable for floor exercises. core: composite foam 80, laminated, cover: textured tarpaulin

ohne Besatz  
without extras

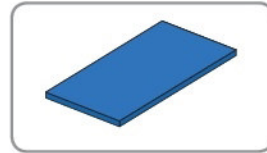

mit Klettecken  
with Velcro® corners

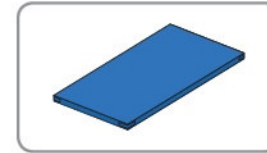

mit Lederecken  
with leather corners

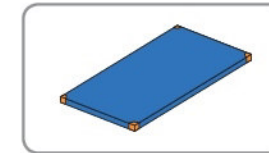

mit Lederecken und Trage-  
schlaufen  
with leather corners and loops

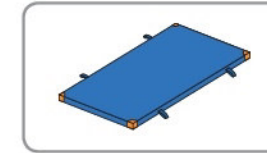

01-5000-Farbe (colour)	01-5000K-Farbe (colour)	01-5000L-Farbe (colour)	01-5000LT-Farbe (colour)
01-5100-Farbe (colour)	01-5100K-Farbe (colour)	01-5100L-Farbe (colour)	01-5100LT-Farbe (colour)
01-5200-Farbe (colour)	01-5200K-Farbe (colour)	01-5200L-Farbe (colour)	01-5200LT-Farbe (colour)
01-5300-Farbe (colour)	01-5300K-Farbe (colour)	01-5300L-Farbe (colour)	01-5300LT-Farbe (colour)

# Super-Leichtturnmatte

super lightweight exercise mat



auch in diesen Farben  
erhältlich:

also available with these  
colours:



1500 x 1000 x 60 mm	6,0 kg	15-1000V-Farbe (colour)	15-1000VK-Farbe (colour)
1500 x 1000 x 80 mm	6,5 kg	15-1100V-Farbe (colour)	15-1100VK-Farbe (colour)
2000 x 1000 x 60 mm	7,0 kg	15-1200V-Farbe (colour)	15-1200VK-Farbe (colour)
2000 x 1000 x 80 mm	7,5 kg	15-1300V-Farbe (colour)	15-1300VK-Farbe (colour)
2000 x 1250 x 60 mm	8,5 kg	15-1400V-Farbe (colour)	15-1400VK-Farbe (colour)
2000 x 1250 x 80 mm	10,5 kg	15-1500V-Farbe (colour)	15-1500VK-Farbe (colour)

Diese leichte Matte ist nur für Bodenübungen in der Vor- und Grundschule, aber nicht für das Gerätturnen geeignet.

Kern: PE Schaum, Bezug - oben und seitlich: Planenstoff, unten: Turnmattenstoff

This lightweight mat is only suitable for floor exercises for nursery and primary school, not for apparatus gymnastics. core: PE foam, cover - top and sides: tarpaulin, bottom: textured tarpaulin

PE-Kern  
PE foam core



ohne Besatz  
without extras

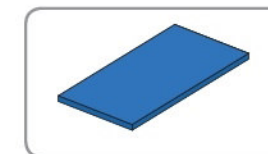

mit Klettecken  
with Velcro® corners

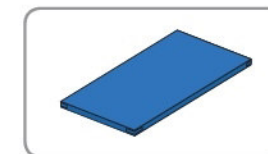



Tummattenstoff, Planenstoff und Leichtplanenstoff: phthalatfrei, Schweißechtheit, Speichelechtheit, Urinbeständigkeit, Lichtechtheit = 7-8 (hervorragend), TMST und PLST: Brennverhalten < 100 mm/min nach ISO 3795 1989 (schwer entflammbar), LPLST: Brennverhalten M2 (schwer entflammbar)

PU-Schaum und Verbundschaum: Öko-Tex zertifiziert

textured tarpaulin, tarpaulin and light tarpaulin: phthalates-free, perspiration resistance, salivary resistance, urine resistance, UV resistance = 7-8 (superb), TT and T flammability < 100 mm/min in accordance with ISO 3795 1989 (hardly inflammable), LT flammability M2 (hardly inflammable)

PU foam and composite foam: Oeko-Tex standard certified



## Faltmatte

folding mat

PE-Kern  
PE foam core



auch in diesen Farben  
erhältlich:  
also available with these  
colours:

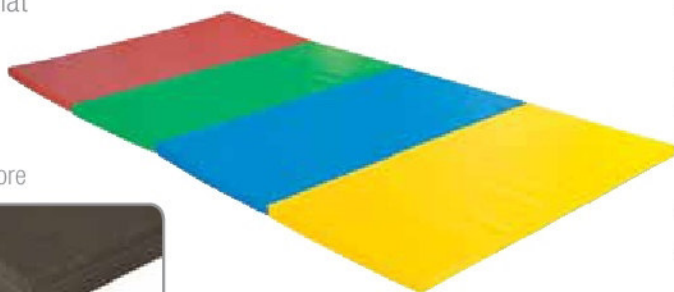

Standard: 4-farbig, Kern: PE-Schaum  
Bezug - oben und seitlich: Leichtplanenstoff, unten: Tummattenstoff

standard: 4 coloured, core: PE foam  
cover - top and sides: tarpaulin, bottom: textured tarpaulin

Art. 29-3002	2400 x 1000 x 30 mm	4-teilig (4-part)
Art. 29-3000	2400 x 1200 x 30 mm	4-teilig (4-part)
Art. 29-3102	3600 x 1000 x 30 mm	6-teilig (6-part)
Art. 29-3100	3600 x 1200 x 30 mm	6-teilig (6-part)
Art. 29-3202	4800 x 1000 x 30 mm	8-teilig (8-part)
Art. 29-3200	4800 x 1200 x 30 mm	8-teilig (8-part)
Art. 29-3302	6000 x 1000 x 30 mm	10-teilig (10-part)
Art. 29-3300	6000 x 1200 x 30 mm	10-teilig (10-part)



## Vario-Step

vario step



jede Matte wird mit 2 Randleisten ausgeliefert  
every mat comes with 2 edge strips

Eine leichte Allround-Matte mit durchdachtem Stecksystem. So kann man größere Flächen fugenlos auslegen. Die Dämpfungseigenschaften sind für stehende Bewegungsabläufe ausgerichtet. Diese Matten sind besonders empfehlenswert für Gymnastikräume oder Ballbäder.

A lightweight all-round mat with a well designed plug-in system, allowing you to lay out larger areas without joints. The damping characteristics of this mat are designed for standing movement sequences. These mats are commendable for gymnastics rooms or ballpools.



Art. 30-4001-12

600 x 600 x 14 mm

Art. 30-4002-12

600 x 600 x 14 mm

Art. 30-4003-12

600 x 600 x 14 mm



## Vario-Top

vario top



jede Matte wird mit 2 Randleisten ausgeliefert  
every mat comes with 2 edge strips

Das Steckmattensystem mit Köpfchen. Denn der EVA-copolymer Schaumstoff RG 90 schützt perfekt vor Stürzen, Stolpern und Fallen.

Mit der einfach zu verlegenden Schwalbenschwanzform entsteht eine einheitliche Fläche. Hervorstehende Kanten werden verhindert. Durch eine ideale Fugenbindung werden Stolpergefahren sowie Haftungsrisiken durch Unebenheiten vermieden.

Sicherheitshinweis: Matten sollten am Boden fixiert werden.

Puzzle mats with brain power. EVA-copolyme foam mats (volume weight 90 kg/m<sup>3</sup>) protect against rush, stumble and fall. They can be easy connected, there are no salient angles and no risk of stumbling.

Security advice: Mats should be fixed on the floor.

Art. 30-3001-12

1000 x 1000 x 25 mm

Art. 30-3002-12

1000 x 1000 x 25 mm

Art. 30-3004-12

1000 x 1000 x 25 mm





## Turnbankschutzpolster

bench padding



Turnbankschutzpolster (bench padding)

auch in diesen Farben  
erhältlich:  
also available with these  
colours:



Verbundschaum-Kern  
composite foam core



Wer kennt das nicht? Die Turnhalle wird mit Turnbänken zu kleinen Spielfeldern umfunktioniert. Und dann ... Bälle rollen unter den Bänken in andere Spielfelder - wichtiger noch, wer achtet beim Spielen auf die Verletzungsgefahr? Im Eifer des Gefechtes stürzt man auf die ungesicherte Turnbank. Damit ist jetzt Schluss!  
Kern: PE-Schaum, Bezug - oben und seitlich: Planenstoff, unten: Turnmattenstoff

Who doesn't know that? Benches serves as boundary for playing field in gym - halls. And then ... balls roll under the benches, more important, who cares about risk of injury? In the heat of the battle, you fall over the unsecured bench. There is an end of it!  
core: PE foam, cover - top and sides: tarpaulin, bottom: textured tarpaulin



Turnmatte (sporting mat)



Seiten- & Werbebande (side & promo board)

Turnbankhöhe 300 mm (bench height 350 mm)

Art. 32-2001

500 x 890 x 30 mm

Art. 32-2011

1000 x 890 x 30 mm

Turnbankhöhe 350 mm (bench height 350 mm)

Art. 32-2010

500 x 1000 x 30 mm

Art. 32-2000

1000 x 1000 x 30 mm

## Bodenturnmatte

floor exercise mat



Die Matte ist auslegbar als große Bodenturnfläche durch Klettverbindungen. Sie besteht aus PE-Schaum mit strapazierfähigem Nadelfilz.

A mat to lay out a big floor exercise area through Velcro® connections. It consists of a PE foam core with durable needle felt.

PE-Kern mit Nadelfilz

PE foam core with needle felt



Art. 9-7000B

2000 x 1000 x 35 mm

Art. 09-0110HLB

Klettband pro lfm. (Velcro® per linear metre)

## Mattengurte

mat belts



Die Gurte sind in diesen Farben erhältlich:  
The belts are available with these colours:



Das Gurtband besteht aus Polypropylen und ist 50 mm breit. Alle Gurte werden ohne Befestigungsmaterial geliefert.

The belt is made of polypropylen and is 50 mm wide. All belts will be delivered without any fixing material.

mit Metallverschluss  
with metal fastener



mit Klettverschluss  
with Velcro® fastener



mit Kunststoffverschluss  
with plastic fastener



4,0 m	gelb (yellow)	04-0800MV
5,0 m	blau (blue)	04-0900MV
6,0 m	rot (red)	04-0960MV

04-0800KV
04-0900KV
04-0960KV

04-0800
04-0900
04-0960

## Mattenwagen Standard

trolley standard



Der Mattenwagen eignet sich zur platzsparenden Mattenaufbewahrung und zum schnellen Auf- und Abbau.  
Hartgummiräder Ø 160 mm, 2 Bock- und 2 Lenkrollen, max. Tragkraft ca. 200 kg  
Versand: teilweise zerlegt, der Griff ist aus transporttechnischen Gründen demontiert.

For space sparing safekeeping of mats and fast building and dismantling.  
Hard rubber wheels Ø 160 mm, 2vfixed castors and 2 castors, max. load capacity approx. 200 kg  
Transport: partially dissembled, mounting bracket demounted.

Art. 12-3012	1000 x 1000 mm
Art. 12-3011	1500 x 1000 mm
Art. 12-3010	2000 x 1000 mm

# Weichboden Standard

landing mat standard



PU-Kern  
PU foam core



Der Weichbodenkern besteht aus Polyurethanschaum. Der Bezug setzt sich aus hochwertigem, hautfreundlichem und nahtlosem Planenstoff (oben, seitlich) und rutschhemmendem Tummattenstoff (unten) zusammen. Ausserdem ist er mit einem Reißverschluss, flach angenähte Tragegriffen und Lüftungslöchern ausgestattet. Art. 04-3300 ist nach DIN EN 12503-1:2013-05 gefertigt.

The landing mat core is made of polyurethane foam. The cover consists of high-quality, skin-friendly and seamless tarpaulin (top, sides) and anti-slip tarpaulin (bottom). In addition it is equipped with a zipper, flat sewn on carry handles and ventilation holes. Item nr. 04-3300 is made in accordance to DIN EN 12503-1:2013-05.

ohne Besatz  
without extras

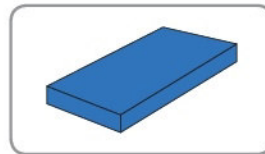

mit Lederecken  
with leather corners

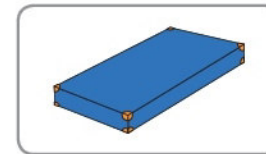

klappbar ohne Besatz  
foldable without extras

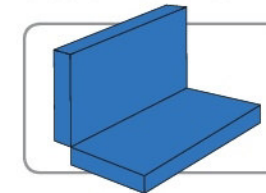

klappbar mit Lederecken  
foldable with leather corners

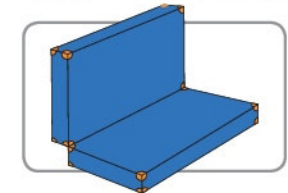

auch in diesen Farben  
erhältlich:  
also available with these  
colours:



Kern: RG 18 (core: volume weight 18 kg/m<sup>3</sup>)

2000 x 1500 x 250 mm	18,5 kg
2000 x 1500 x 300 mm	21,0 kg
3000 x 2000 x 250 mm	36,0 kg
3000 x 2000 x 300 mm	41,0 kg

04-1000-Farbe (colour)
04-1100-Farbe (colour)
04-1200-Farbe (colour)
04-1300-Farbe (colour)

04-1000LE-Farbe (colour)
04-1100LE-Farbe (colour)
04-1200LE-Farbe (colour)
04-1300LE-Farbe (colour)

04-5000-Farbe (colour)
04-5100-Farbe (colour)
04-5200-Farbe (colour)
04-5300-Farbe (colour)

04-5000LE-Farbe (colour)
04-5100LE-Farbe (colour)
04-5200LE-Farbe (colour)
04-5300LE-Farbe (colour)

Art. 04-2300  
ist nach DIN EN 12503-  
1:2013-05 Typ 7 gefertigt  
item nr. 04-2300 is produced  
in accordance to DIN EN  
12503-1:2013-05 typ 7



Kern: RG 20 (core: volume weight 20 kg/m<sup>3</sup>)

2000 x 1500 x 250 mm	20,5 kg
2000 x 1500 x 300 mm	24,0 kg
3000 x 2000 x 250 mm	39,5 kg
3000 x 2000 x 300 mm	46,0 kg

04-2000-Farbe (colour)
04-2100-Farbe (colour)
04-2200-Farbe (colour)
04-2300-Farbe (colour)

04-2000LE-Farbe (colour)
04-2100LE-Farbe (colour)
04-2200LE-Farbe (colour)
04-2300LE-Farbe (colour)

04-6000-Farbe (colour)
04-6100-Farbe (colour)
04-6200-Farbe (colour)
04-6300-Farbe (colour)

04-6000LE-Farbe (colour)
04-6100LE-Farbe (colour)
04-6200LE-Farbe (colour)
04-6300LE-Farbe (colour)

Art. 04-3300  
ist nach DIN EN 12503-  
1:2013-05 Typ 8 gefertigt  
item nr. 04-3300 is produced  
in accordance to DIN EN  
12503-1:2013-05 typ 8



Kern: RG 23 (core: volume weight 23 kg/m<sup>3</sup>)

2000 x 1500 x 250 mm	23,0 kg
2000 x 1500 x 300 mm	27,0 kg
3000 x 2000 x 250 mm	42,5 kg
3000 x 2000 x 300 mm	50,0 kg

04-3000-Farbe (colour)
04-3100-Farbe (colour)
04-3200-Farbe (colour)
04-3300-Farbe (colour)

04-3000LE-Farbe (colour)
04-3100LE-Farbe (colour)
04-3200LE-Farbe (colour)
04-3300LE-Farbe (colour)

04-7000-Farbe (colour)
04-7100-Farbe (colour)
04-7200-Farbe (colour)
04-7300-Farbe (colour)

04-7000LE-Farbe (colour)
04-7100LE-Farbe (colour)
04-7200LE-Farbe (colour)
04-7300LE-Farbe (colour)

Kern: RG 25 (core: volume weight 25 kg/m<sup>3</sup>)

3000 x 2000 x 300 mm	55,0 kg
----------------------	---------

04-4300-Farbe (colour)
------------------------

04-4300LE-Farbe (colour)
--------------------------

# Weichboden WEBO

landing mat WEBO



Der Weichboden WEBO ist eine preiswerte Alternative. Der Weichbodenkern besteht aus Polyurethanschäum. Der Bezug setzt sich aus glattem, hautfreundlichem und nahtlosem Planenstoff (oben, seitlich) und Turnmattenstoff (unten) zusammen. Ausserdem ist er mit einem Reißverschluss, Tragegriffe und Lüftungslöchern ausgestattet.

The landing mat WEBO is an affordable alternative. The core is made of polyurethane foam. The cover consists of smooth, skin-friendly and seamless tarpaulin (top, sides) and anti-slip tarpaulin (bottom). In addition it is equipped with a zipper, carry handles and ventilation holes.

ohne Besatz  
without extras

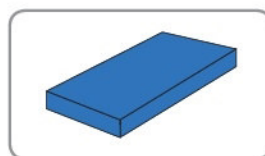

mit Lederecken  
with leather corners

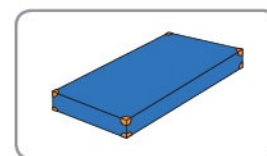

klappbar ohne Besatz  
foldable without extras

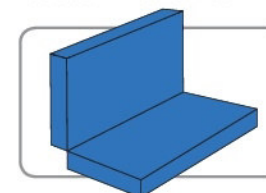

klappbar mit Lederecken  
foldable with leather corners

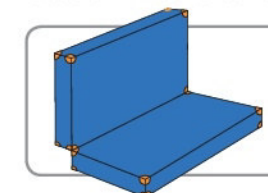

PU-Kern  
PU foam core



Kern: RG 18 (core: volume weight 18 kg/m<sup>3</sup>)

2000 x 1500 x 250 mm	18,5 kg
2000 x 1500 x 300 mm	21,0 kg
3000 x 2000 x 250 mm	36,0 kg
3000 x 2000 x 300 mm	41,0 kg

04-1000G18
04-1100G18
04-1200G18
04-1300G18

04-1000G18-L8
04-1100G18-L8
04-1200G18-L8
04-1300G18-L8

04-5000G18
04-5100G18
04-5200G18
04-5300G18

04-5000G18-L8
04-5100G18-L8
04-5200G18-L8
04-5300G18-L8

Kern: RG 20 (core: volume weight 20 kg/m<sup>3</sup>)

2000 x 1500 x 250 mm	20,5 kg
2000 x 1500 x 300 mm	24,0 kg
3000 x 2000 x 250 mm	39,5 kg
3000 x 2000 x 300 mm	46,0 kg

04-2000G20
04-2100G20
04-2200G20
04-2300G20

04-2000G20-L8
04-2100G20-L8
04-2200G20-L8
04-2300G20-L8

04-6000G20
04-6100G20
04-6200G20
04-6300G20

04-6000G20-L8
04-6100G20-L8
04-6200G20-L8
04-6300G20-L8

Kern: RG 23 (core: volume weight 23 kg/m<sup>3</sup>)

2000 x 1500 x 250 mm	23,0 kg
2000 x 1500 x 300 mm	27,0 kg
3000 x 2000 x 250 mm	42,5 kg
3000 x 2000 x 300 mm	50,0 kg

04-3000G23
04-3100G23
04-3200G23
04-3300G23

04-3000G23-L8
04-3100G23-L8
04-3200G23-L8
04-3300G23-L8

04-7000G23
04-7100G23
04-7200G23
04-7300G23

04-7000G23-L8
04-7100G23-L8
04-7200G23-L8
04-7300G23-L8

Kern: RG 25 (core: volume weight 25 kg/m<sup>3</sup>)

3000 x 2000 x 300 mm	55,0 kg
----------------------	---------

04-4300G25
------------

04-4300G25-L8
---------------

# Was ist die Fallhöhe?

What is a drop height?

Es ist immer auf einen ausreichenden Fallschutz zu achten. Dieser muss den Anforderungen der DIN EN 1177 bzw. der DIN EN 12503 entsprechen. Zur Dimensionierung des Sicherheitsbereiches ist die EN 1176-1 heranzuziehen.

It should mind an adequate fall protection. It should conform to DIN/EN 1177 or/and DIN/EN 12503. To fix the dimension of safety zone EN 1176-1 should be drawn upon.



Laut DIN EN 1177:2008-08 ist die Fallhöhe der Abstand zwischen der Prüfposition auf dem Boden und dem untersten Rand des frei fallenden Prüfkopfes vor Auslösung.

DIN EN 1177:2008-08 says that the drop height is the distance between the test position on the floor and the lowest edge of the free falling test head before trigger.

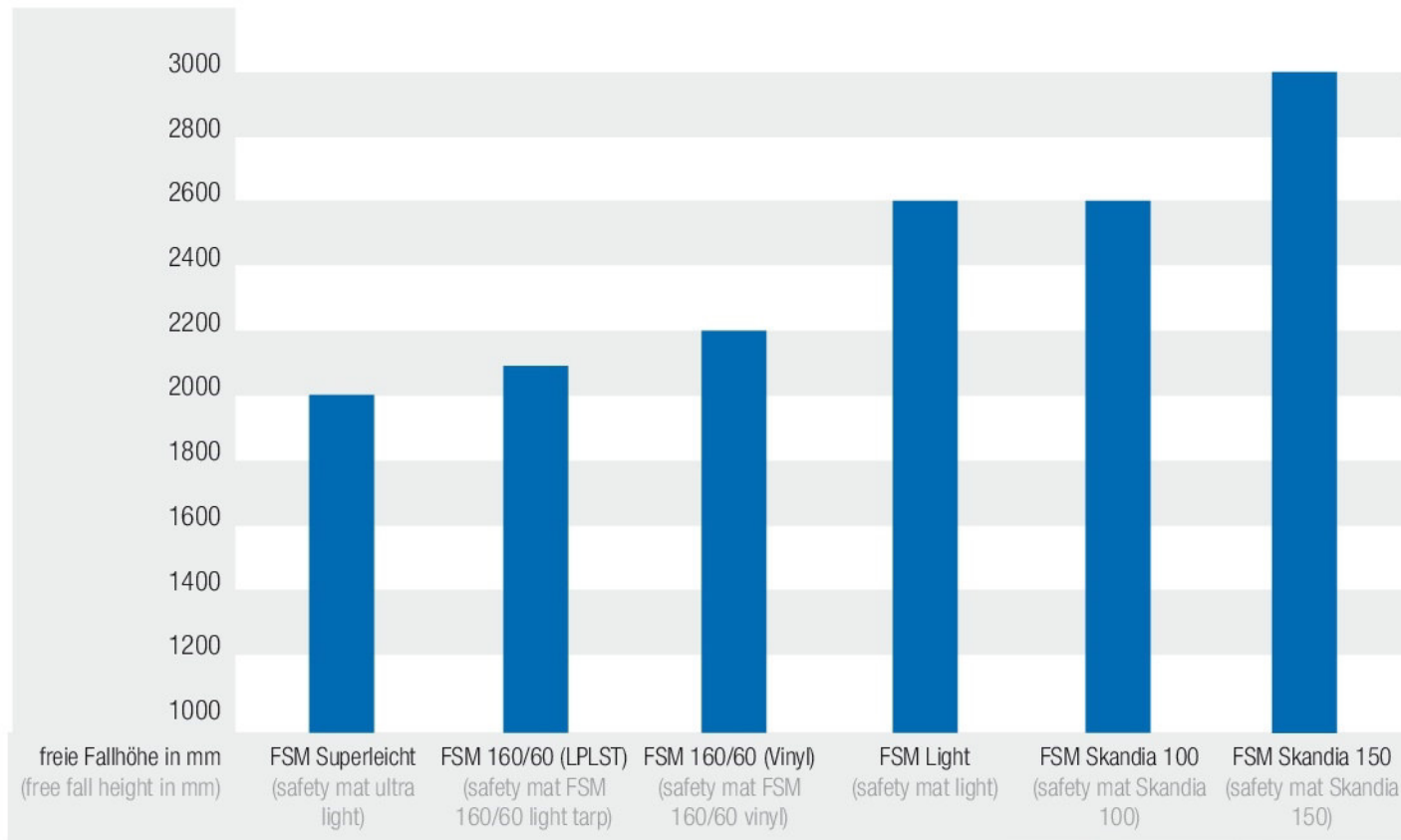

## FSM Superleicht

safety mat ultra light (up to 2000 mm)



Fallhöhe bis 2000 mm

auch in diesen Farben  
erhältlich:  
also available with these  
colours:



Kern: PE-Schaum, Bezug - oben und seitlich: Leichtplanenstoff, unten: Turnmattenstoff, Reißverschluss  
core: PE foam, cover - top and sides: light tarpaulin, bottom: textured tarpaulin, zipper



Die freie Fallhöhe nach DIN EN 1177:2008-08 wurde von TÜV Thüringen Anlagentechnik GmbH & Co KG ermittelt.  
The drop height is determined by TÜV Thüringen (technical supervision agency) in accordance to DIN EN 1177:2008-08.

PE-Kern  
PE foam core



1000 x 1000 x 60 mm  
1500 x 1000 x 60 mm  
2000 x 1000 x 60 mm

3,5 kg  
5,2 kg  
7,0 kg

ohne Besatz  
without extras

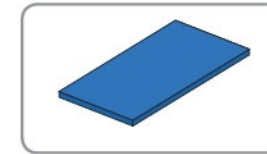

19-6300-Farbe (colour)  
19-6301-Farbe (colour)  
19-6302-Farbe (colour)

mit Klettecken  
with Velcro® corners

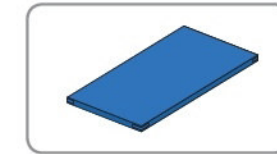

19-6200-Farbe (colour)  
19-6201-Farbe (colour)  
19-6202-Farbe (colour)

## Fallschutzmatte FSM 160/60 (LPLST)

safety mat FSM 160/60 light tarpaulin (up to 2100 mm)



Fallhöhe bis 2100 mm

auch in diesen Farben  
erhältlich:  
also available with these  
colours:



Kern: funktionell abgestimmter Verbundschaum 160  
Bezug - oben und seitlich: Leichtplanenstoff, unten: Turnmattenstoff, Reißverschluss  
core: functional choiced composite foam 160  
cover - top and sides: light tarpaulin, bottom: textured tarpaulin, zipper



Die freie Fallhöhe nach DIN EN 1177:2008-08 wurde von TÜV Thüringen Anlagentechnik GmbH & Co KG ermittelt.  
The drop height is determined by TÜV Thüringen (technical supervision agency) in accordance to DIN EN 1177:2008-08.

Verbundschaum-Kern  
composite foam core



1000 x 1000 x 60 mm  
1500 x 1000 x 60 mm  
2000 x 1000 x 60 mm

10,0 kg  
15,0 kg  
20,0 kg

ohne Besatz  
without extras

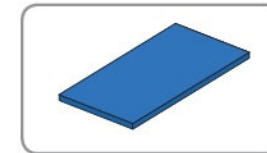

19-2100-Farbe (colour)  
19-2101-Farbe (colour)  
19-2102-Farbe (colour)

mit Klettecken  
with Velcro® corners

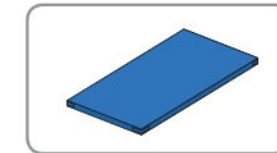

19-2100K-Farbe (colour)  
19-2101K-Farbe (colour)  
19-2102K-Farbe (colour)

## Fallschutzmatte FSM 160/60 (Vinyl)

safety mat FSM 160/60 (vinyl) (up to 2200 mm)

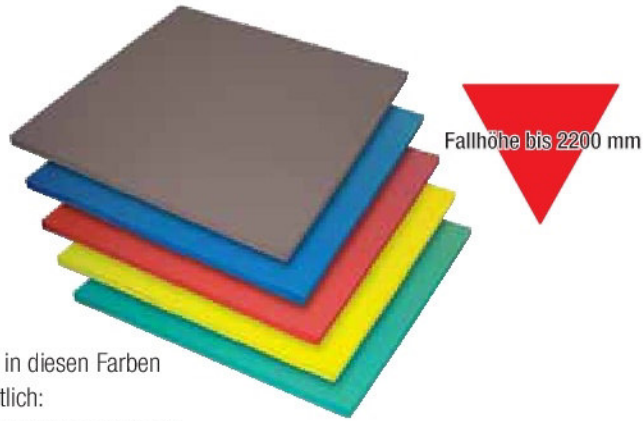

auch in diesen Farben  
erhältlich:  
also available with these  
colours:



Kern: funktionell abgestimmter Verbundschaum 160  
Bezug - oben und seitlich: profiliertes Vinyl, unten: Waffelboden, verklebt  
core: functional choiced rebounded foam 160  
cover - top and sides: light tarpaulin, bottom: anti-slip material, glued



Die freie Fallhöhe nach DIN EN 1177:2008-08 wurde von TÜV Thüringen Anlagentechnik GmbH & Co KG ermittelt.  
The drop height is determined by TÜV Thüringen (technical supervision agency) in accordance to DIN EN 1177:2008-08.

Verbundschaum-Kern  
composite foam core



1000 x 1000 x 60 mm  
1500 x 1000 x 60 mm  
2000 x 1000 x 60 mm

10,0 kg  
15,0 kg  
20,0 kg

ohne Besatz  
without extras

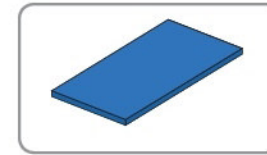

19-2000-Farbe (colour)  
19-2001-Farbe (colour)  
19-2002-Farbe (colour)

mit Klettecken  
with Velcro® corners

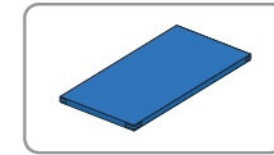

19-2000K-Farbe (colour)  
19-2001K-Farbe (colour)  
19-2002K-Farbe (colour)

## Fallschutzmatte Light

safety mat light (up to 2600 mm)



auch in diesen Farben  
erhältlich:  
also available with these  
colours:



Kern: PE-Schaum  
Bezug - oben und seitlich: profiliertes Vinyl, unten: Waffelboden, verklebt  
core: PE foam  
cover - top and sides: light tarpaulin, bottom: anti-slip material, glued



Die freie Fallhöhe nach DIN EN 1177:2008-08 wurde von TÜV Thüringen Anlagentechnik GmbH & Co KG ermittelt.  
The drop height is determined by TÜV Thüringen (technical supervision agency) in accordance to DIN EN 1177:2008-08.

PE-Kern  
PE foam core



1000 x 1000 x 60 mm  
1500 x 1000 x 60 mm  
2000 x 1000 x 60 mm

3,4 kg  
5,1 kg  
7,4 kg

ohne Besatz  
without extras

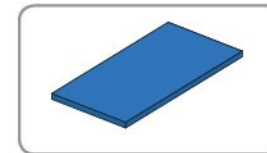

19-6100-Farbe (colour)  
19-6101-Farbe (colour)  
19-6102-Farbe (colour)

mit Klettecken  
with Velcro® corners

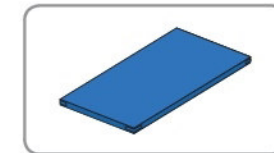

19-6400-Farbe (colour)  
19-6401-Farbe (colour)  
19-6402-Farbe (colour)

## Fallschutzmatte Skandia 100

safety mat Skandia 100 (up to 2600 mm)



Fallhöhe bis 2600 mm



Kern: funktionell abgestimmter Sandwichkern

Bezug - oben und seitlich: Leichtplanenstoff, unten: Turnmattenstoff, Reißverschluss

core: functional choiced sandwich core, cover - top and sides: light tarpaulin, bottom: textured tarpaulin, zipper

Die freie Fallhöhe nach DIN EN 1177:2008-08 wurde von TÜV Süd ermittelt.

The drop height is determined by TÜV Süd (technical supervision agency) in accordance to DIN EN 1177:2008-08.

auch in diesen Farben  
erhältlich:

also available with these  
colours:



Sandwichkern  
sandwich core



1000 x 1000 x 100 mm  
1500 x 1000 x 100 mm  
2000 x 1000 x 100 mm  
2000 x 1500 x 100 mm

6,0 kg  
9,0 kg  
12,0 kg  
18,0 kg

ohne Besatz  
without extras

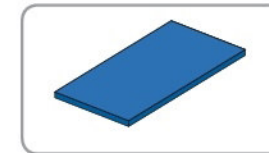

19-3000-Farbe (colour)  
19-3001-Farbe (colour)  
19-3002-Farbe (colour)  
19-3003-Farbe (colour)

mit Klettecken  
with Velcro® corners

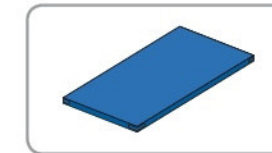

19-3000K-Farbe (colour)  
19-3001K-Farbe (colour)  
19-3002K-Farbe (colour)  
19-3003K-Farbe (colour)

## Fallschutzmatte Skandia 150

safety mat Skandia 150 (up to 3000 mm)



Fallhöhe bis 3000 mm



Kern: funktionell abgestimmter Sandwichkern,

Bezug - oben und seitlich: Leichtplanenstoff, unten: Turnmattenstoff, Reißverschluss

core: functional choiced sandwich core, cover - top and sides: light tarpaulin, bottom: textured tarpaulin, zipper

Die freie Fallhöhe nach DIN EN 1177:2008-08 wurde von TÜV Thüringen Anlagentechnik GmbH & Co KG ermittelt.

The drop height is determined by TÜV Thüringen (technical supervision agency) in accordance to DIN EN 1177:2008-08.

auch in diesen Farben  
erhältlich:

also available with these  
colours:



Sandwichkern  
sandwich core



1500 x 1000 x 150 mm  
1500 x 1000 x 150 mm  
2000 x 1000 x 150 mm  
2000 x 1500 x 150 mm

9,0 kg  
13,5 kg  
18,0 kg  
24,0 kg

ohne Besatz  
without extras

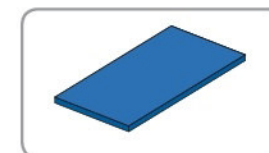

19-3100-Farbe (colour)  
19-3101-Farbe (colour)  
19-3102-Farbe (colour)  
19-3103-Farbe (colour)

mit Klettecken  
with Velcro® corners

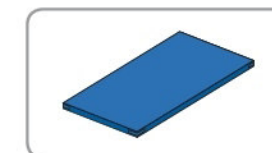

19-3100K-Farbe (colour)  
19-3101K-Farbe (colour)  
19-3102K-Farbe (colour)  
19-3103K-Farbe (colour)



## Fallschutzmatte Turm Skandia

safety mat tower Skandia (up to 2600 mm)



Fallhöhe bis 2600 mm

auch in diesen Farben  
erhältlich:  
also available with these  
colours:



Kern: funktionell abgestimmter Sandwichkern  
Bezug - oben und seitlich: Leichtplanenstoff, unten: Turnmattenstoff, Reißverschluss  
core: functional choiced sandwich core  
cover - top and sides: light tarpaulin, bottom: textured tarpaulin, zipper

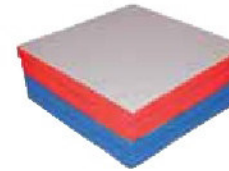

gefaltet (folded): 1000 x 1000 x 400 mm

Sandwichkern  
sandwich core



Art. 19-5300-Farbe (colour) 2000 x 2000 x 100 mm



## Fallschutzmatte Sofa Skandia

safety mat couch Skandia (up to 2600 mm)



Fallhöhe bis 2600 mm

auch in diesen Farben  
erhältlich:  
also available with these  
colours:



Kern: funktionell abgestimmter Sandwichkern  
Bezug - oben und seitlich: Leichtplanenstoff, unten: Turnmattenstoff, Reißverschluss  
core: functional choiced sandwich core  
cover - top and sides: light tarpaulin, bottom: textured tarpaulin, zipper

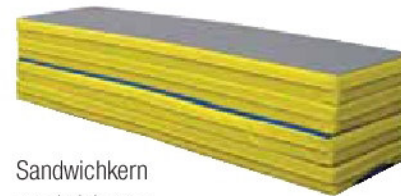

gefaltet (folded): 2000 x 500 x 400 mm

Sandwichkern  
sandwich core



Art. 19-5200-Farbe (colour) 2000 x 2000 x 100 mm

# Individualfertigung - mit Ihrem Branding

individual manufacture - with your branding



Ihre Turnhalle, Spiellandschaft oder ihr Timeout-Raum hat noch Ecken und Kanten? Egal ob Schutzpolster, Prallschuttmatten oder Sitz- und Liegellandschaften, wir finden für jedes Problem eine passende Lösung. Unser Verkaufsteam berät Sie gern und kompetent.

Sie haben Sponsoren oder wünschen sich ein ganz besonderes Aussehen für ihre Matte? Wir bieten Lackierungen, Beschriftungen sowie Digitaldruck an, um ihre Vorstellungen auf ihre Matte zu bringen.

Does your gym, your playing scenery or your timeout room still has rough edges? No matter if you need protection pads, fall protection or sitting and lying sceneries, we have a solution for every problem. Our sales team advises you competently.

Do you have sponsors or are you looking for special appearance of your mat? We offer varnishes, labels and digital prints to get your ideas on your mat.



Turnmattenstoff, Planenstoff und Leichtplanenstoff: phthalatfrei, Schweißechtheit, Speicherechtheit, Urinbeständigkeit, Lichtechtheit = 7-8 (hervorragend), TMST und PLST: Brennverhalten < 100 mm/min nach ISO 3795 1989 (schwer entflammbar), LPLST: Brennverhalten M2 (schwer entflammbar)

PU-Schaum und Verbundschaum: Öko-Tex zertifiziert



textured tarpaulin, tarpaulin and light tarpaulin: phthalates-free, perspiration resistance, salivary resistance, urine resistance, UV resistance = 7-8 (superb), TT and T flammability < 100 mm/min in accordance with ISO 3795 1989 (hardly inflammable), LT flammability M2 (hardly inflammable)

PU foam and composite foam: Oeko-Tex standard certified



# individuelle Fallschutzlösungen

individual fall protection solutions



Bänfer Fallschutzsysteme sind in verschiedenen Kernauführungen erhältlich. Sie haben alle eine Plane aus strapazierfähigem Planenstoff mit einem Mindestflächengewicht von 550g/m<sup>2</sup>, die direkt auf die Kerne mit einem zum Patent angemeldeten Klett-system (EP 2 554 223 A1) aufgeklebt wird. Dadurch wird selbst das komplizierteste Klettergerüst perfekt in die Matte integriert. Vor Ort werden Kerne und Plane von erfahrenen Bänfer-Monteuren passgenau verlegt und an die Kletterwand oder das Spielgerät angepasst. Ausschnitte werden zusätzlich verstärkt. Alle Flächen werden so ohne Stolperkanten, Fugen oder lose Fugenlaschen verlegt. Selbst Schrägen, Treppen oder Kletternetze können in die Matte integriert oder geschützt werden. Unser Projekt-Team berät und unterstützt Sie von der Planung bis zur Umsetzung Ihrer Mattenfläche.

Bänfer fall protection systems are available in different core designs. They all have a cover made of durable tarpaulin material with a minimum basis weight of 550g / m<sup>2</sup>, which is connected by Velcro® directly onto the cores. Due to it, the most complicated climbing frame is perfectly integrated into the mat. Experienced Bänfer fitters transfer and adapt the fall protection mats to any climbing wall or any playground equipment. Cutouts are reinforced. All surfaces are laid without stumbling edges, joints or loose joint tabs. Even slopes, stairs or climbing nets can be integrated or protected in the mat. Our project team provides advice and supports you from the planning to realization of your mat area.



# Varianten der Fallschutzsysteme

variants of the fall protection systems



Fallschutzmatte FSM 100/100



Fallschutzmatte FSM 160/60



Skandia 100



Skandia 150



Landematte Standard



Fallhöhe bis 2100 mm



Fallhöhe bis 2600 mm



Fallhöhe bis 3000 mm

## Fallschutzmatte FSM 100/100 – safety mat FSM 100/100

Kern: Verbundschaum 100, Höhe: 100 mm, 10 kg/m<sup>2</sup>  
core: rebounded foam 100, height: 100 mm, 10 kg/m<sup>2</sup>

Art. 19-2300-Farbe (colour)

## Fallschutzmatte FSM 160/60 – safety mat FSM 160/60

Kern: Verbundschaum 160, Höhe: 60 mm, 10 kg/m<sup>2</sup>  
core: rebounded foam 160, height: 60 mm, 10 kg/m<sup>2</sup>

Art. 19-2105-Farbe (colour)

## Fallschutzmatte Skandia 100 – safety mat skandia 100

Kern: Kombikern - Trittverteilerfläche fest verklebt mit weicherem Polyätherschaum (RG 25)  
core: combined core - tread distributor surface firmly bonded to a softer polyether foam (volume weight 25)  
Höhe: 100 mm, 6 kg/m<sup>2</sup>, height: 100 mm, 6 kg/m<sup>2</sup>

Art. 19-3005-Farbe (colour)

## Fallschutzmatte Skandia 150 – safety mat skandia 150

Kern: Kombikern - Trittverteilerfläche fest verklebt mit weicherem Polyätherschaum (RG 25)  
core: combined core - tread distributor surface firmly bonded to a softer polyether foam (volume weight 25)  
Höhe: 150 mm, 9 kg/m<sup>2</sup>, height: 150 mm, 9 kg/m<sup>2</sup>

Art. 19-3105-Farbe (colour)

## Landematte Standard – landing mat standard

Kern: PU-Schaum (RG 25), Höhe: 200-400 mm, 25 kg/m<sup>2</sup>  
core: PU foam (volume weight 25), height: 200-400 mm, 25 kg/m<sup>2</sup>

Art. 19-8600-Farbe (colour)

Alle Matten sind in diesen Farben erhältlich

all mats are available with these colours:

 weitere Farben auf Anfrage! (More colours on request.)

## individuelle Schutzpolster

individual protection pads



Diese Gefahren kennen Sie ...

Eisenträger, die vorstehen, unverkleidete Heizkörper und Geländer, die täglich Schutz beim Treppen rauf und runtergehen gewährleisten sollen, sind potentielle Gefahrenquellen bei unkontrollierten Stürzen. Erkennen Sie Gefahrenquellen und schalten Sie diese mit individuell angepassten Schutzpolstern aus. Wir fertigen individuelle Schutzpolster auf Maß, passend zu Ihrem Geländer, Eisenträger, etc.

You know the hazards ...

Dangerous beams, uncovered radiators and railings are potential hazards by falls. Find this origin of danger and stop them through protection pads. We produce the paddings individually and true to size.

Alle Schutzpolster sind in diesen Farben erhältlich:

All paddings are available with these colours:



## Säulenschutzpolster, rund

circular pillar protection pads

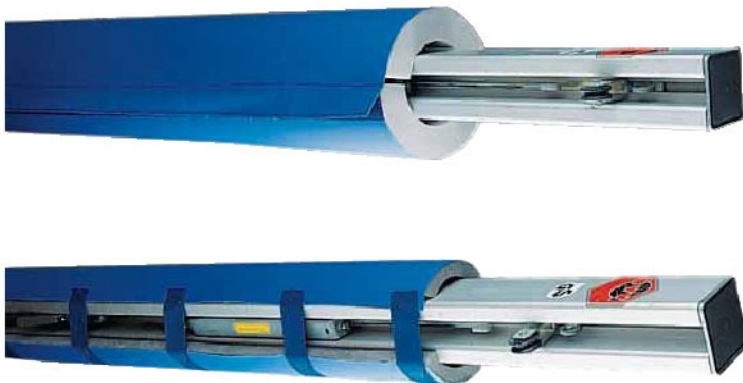

Standard-Ausführung: PU-Schaumkern mit strapazierfähigem Planenstoff-Überzug und durchgehender Klettbandleiste

Super: PE-Schaumkern mit strapazierfähigem Planenstoff-Überzug und Klettbandverschlüssen

Standard design: PU foam core with durable tarpaulin cover and continuous velcro tape strip

Super: PE foam core with durable tarpaulin fabric cover and Velcro® tape fastenings

Art. 32-1000-Farbe

Innen: Ø 120 mm, Aussen: Ø 220 mm, Wandstärke: 50 mm, Länge: 2000 mm  
inside: Ø 120 mm, outside: Ø 220 mm, wall thickness: 50 mm, length: 2000 mm

Art. 32-1100-Farbe

Innen: Ø 90 mm, Aussen: Ø 130 mm, Wandstärke: 20 mm, Länge: 2000 mm  
inside: Ø 90 mm, outside: Ø 130 mm, wall thickness: 20 mm, length: 2000 mm

Art. 32-1150-Farbe

Innen: Ø 114 mm, Aussen: Ø 154 mm, Wandstärke: 20 mm, Länge: 2000 mm  
inside: Ø 114 mm, outside: Ø 154 mm, wall thickness: 20 mm, length: 2000 mm

## Prallschutz für Säulen, quadratisch

quadratic pillar protection pads



Bestehend aus einem 30 mm festen Leichtschaumkern, mit Planenstoff bezogen, mit durchgehender Klettlasche, auch für den Aussenbereich geeignet.

Consists of a 30 mm PE-foam core, covered with tarpaulin and with a full Vecro® flap, suitable for outdoor use.

Art. 32-2100-Farbe (colour)

Länge 1000 mm x Säulenmaß  
length 1000 mm x pillar measure

Art. 32-2110-Farbe (colour)

Länge 2000 mm x Säulenmaß  
length 2000 mm x pillar measure

## Prallschutz für Ecken

paddings for corners

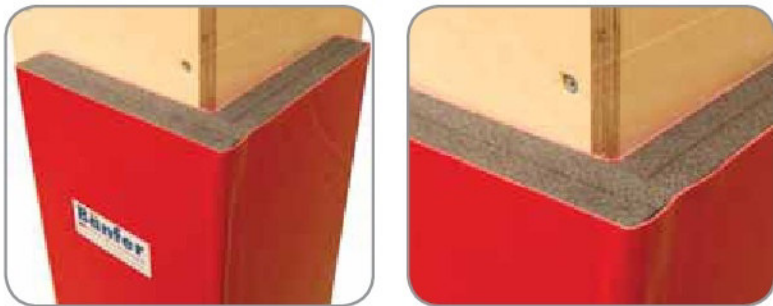

Eckpolster für Gefahrenecken, wie z.B. Türrahmen, Wandecken und Fensterbänke. Das Polster aus festem Leichtschaumkern ist mit einem 30 mm starken Haftstreifen zu befestigen. Schenkellänge: 200 mm

Corner pads for dangerous corners, e.g. door frames, wall corners and window sills. The cushion of solid PE foam core is equipped with a 30 mm strong adhesive strips. side length: 200 mm

Art. 32-2400-Farbe (colour)

Länge 1000 mm  
length 1000 mm

Art. 32-2410-Farbe (colour)

Länge 2000 mm  
length 2000 mm

## Prallschutz für Doppel-T-Träger

paddings for double T-girder



Das Schutzpolster wird an Stahlträger oder Säulen angepasst. Es besteht aus einem Schaumkern mit einer Wandstärke von 50-100 mm und ist mit Planenstoff bezogen. So schützt das Polster optimal vor bösen Verletzungen.

The padding is adjusted to double T-girders or pillars. It consists of a foam core with a wall thickness of 50-100 mm and is covered with tarpaulin. It protects perfect against nasty injuries.

Art. 32-1400-Farbe (colour)

Länge 2000 mm  
length 2000 mm

## Prallschutz für Außenbereiche

padding for outdoor areas



Dieser Prallschutz ist vollverschweißt und somit Spritzwasser geschützt. Er ist ideal für Außenbereiche geeignet, wie z.B. Bikeparks. Wie alle Säulenprallschutzmodelle wird er natürlich individuell auf Ihre Bedürfnisse und Gefahrenstellen gefertigt. Mit Ösenlaschen

This padding is appropriate for outdoor areas like bike parks because it is fully welded. By welding this variant is splash protected. We produce all paddings individually to your needs and hazards. Flap with eyelets

Art. 19-1900-Farbe (colour)

1500 x 500 x 80 mm

Art. 19-1910-Farbe (colour)

2000 x 1000 x 80 mm

## Prallschutz für Heizkörper und Fensterbank

padding for radiators and window sill



Ein Wegrutschen ist meist mit bösen Verletzungen verbunden. Diese gilt es zu vermeiden. Individuell gefertigte Prallschützer helfen Ihnen, Gefahren auszuschalten.

Alle Prallschutzmodelle für Heizkörper und Fensterbänke werden individuell für Ihre Bedürfnisse und Gefahrenstellen gefertigt.

Slipping is usually associated with bad injuries. Injuries should be avoided.

Custom-made protection paddings help to eliminate hazards. We produce all paddings for radiators and windowsills individually to your needs and hazards.

## Schutzpolster für Kletteranlagen

padding for climbing facilities



Ein Wegrutschen ist meist mit bösen Verletzungen verbunden. Diese gilt es zu vermeiden. Individuell gefertigte Prallschützer helfen Ihnen, Gefahren auszuschalten.

Alle Säulenprallschutzmodelle werden auch individuell für Ihre Bedürfnisse und Gefahrenstellen gefertigt.

Slipping is usually associated with bad injuries. Injuries should be avoided.

Custom-made protection paddings help to eliminate hazards. We produce all paddings individually to your needs and hazards.

## Schutzpolster für Sprossenwand

paddings for wall bars



Dieser Polstersatz ist für Sprossenwangen für Normsprossenwände nach DIN 7910 geeignet. Er ist ideal für starre und schwenkbare abstehende Wände in Turnhallen. Er besteht aus einem 30 mm starken PE-Kern und ist vollflächig mit Planenstoff beklebt. Er ist mit 5 Klettaschen zur Befestigung ausgestattet. Länge: 2000 mm

This set of protective cushions for sides of wall bars is made in accordance with DIN 7910. It is ideal for fixed and swivelling bars in the gym. It consists of a 30 mm PE foam core with a tarpaulin fabric cover and 5 Velcro® fastenings. length: 2000 mm

- |              |   |
|--------------|---|
| Art. 32-1500 | 1 Paar Schutzpolster für Sprossenwand starr<br>1 pair of protective cushions for fixed wall bars                        |
| Art. 32-1510 | 1 Paar Schutzpolster für Sprossenwand schwenkbar links<br>1 pair of protective cushions for wall bars swivelling left   |
| Art. 32-1520 | 1 Paar Schutzpolster für Sprossenwand schwenkbar rechts<br>1 pair of protective cushions for wall bars swivelling right |

## Projektarbeit

project related work



Planen Sie die Gestaltung eines Kindergartens, den Bau einer neuen Turnhalle, einer Schnitzelgrube oder ein Projekt, das keinen Standards entspricht? Für unsere Projektabteilung ein leichtes Spiel. Unser Knowhow wird Ihnen von der Idee bis hin zur Realisierung weiterhelfen. Wir geleiten Sie durch das Projekt und antworten bei Problemstellungen mit Lösungen.

Schauen Sie doch mal in unseren Projektflyer oder auf unsere Internetseite: [www.baenfer.de](http://www.baenfer.de)

Do you plan the configuration of a kindergarten, the construction of a new sports hall, landing pits or a project which does not comply with any standards? This is an easy game for our project department. Our knowhow will support you from your idea to the realization. We steer you through the whole project and help with solutions if there is a problem.

Please do not hesitate to have a look into our project flyer or on our website: [www.baenfer.de](http://www.baenfer.de)



# Timeout-Räume

timeout rooms



Zurückgreifend auf über 30 Jahre Erfahrung im Bereich Fall- und Prallschutz, konzeptionieren wir für Sie Ihren TIMEOUT-Raum individuell, professionell und vor allem sicher!  
(nach Aufmaß oder Zeichnung)

We are falling back to more than 30 years of experience in fall protection and padding systems. This is why we can create your individual, professional and safe timeout room.  
(with measurement and subscription)

Alle Schutzpolster sind in diesen Farben erhältlich:  
All paddings are available with these colours:



# Snoezelenräume

Snoezelen rooms



Himmlische Ruhe findet man in dem mit neutralen weißen Grundelementen gestalteten Raum. Daraus ergibt sich die Möglichkeit, gezielt therapeutische Intentionen einzusetzen. Im klassischen Konzept wurde folgende Ideologie integriert: „Nichts muss gemacht werden - alles ist erlaubt!“ Weiche und bequeme Liege- und Entspannungslandschaft aus hochwertigem Leichtplanenstoff mit rutschhemmender Unterseite. Der eingesetzte hochwertige Schaumstoffkern sorgt für sicheres und nicht zu tiefes Eindringen in die Matten. Sicheres Laufen und dennoch weiches und komfortables Liegen ist gewährleistet. Selbstverständlich sind Sondergrößen sowie andere Bezugsstoffe jederzeit möglich. Das Verrutschen der Matten wird durch einen rutschhemmenden Belag auf der Unterseite vermieden.

Heavenly feelings occur through the white basic elements. There is the possibility to apply focused therapeutic intentions. The classic concept says: "Nothing needs to be done - everything is allowed." Soft and comfortable lying and relaxing landscape of high-quality light tarpaulin material with slip-resistant bottom. Safe walking and comfortable lying is assured. Special sizes and other reference materials are available any time. The slipping of the mat is avoided through a non-slip covering on the underside.

1	Art. 96-030	Ballbad weiß mit Lichtschlauch ball pool with light tube	2250 x 2250 x 500 mm
2	Art. 36-940	Snoezelhaus mit Spiegelwand Snoezel house with a mirror wall	1250 x 1250 x 1250 mm
3	Art. 16-5030we	Kuschelkissen weiß cuddle pillow	2000 x 2000 mm
4	Art. 96-078	Sitzsack weiß Beanbag pillow	Ø 1000 mm
5	Art. 94-400	Dreiviertelkreis three-quarter circle	1300 x 1300 x 330 mm
6	Art. 94-500	Viertelkreis quarter circle	Ø 650 x 330 mm
7	Art. 94-300	Podest Quadrat, groß platform square, big	1300 x 1300 x 330 mm
8	Art. 94-901	Rundpodest mit Aufnahme für Säule round platform with pillar space	Ø 1300 x 430 mm
9	Art. 94-801	Eckpodest mit Aufnahme für Säule corner platform with pillar space	1300 x 1300 x 430 mm

# Wandmatten

wall mats

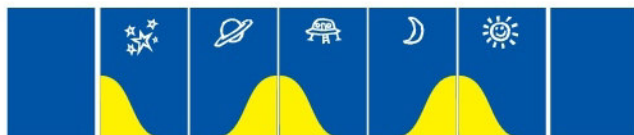
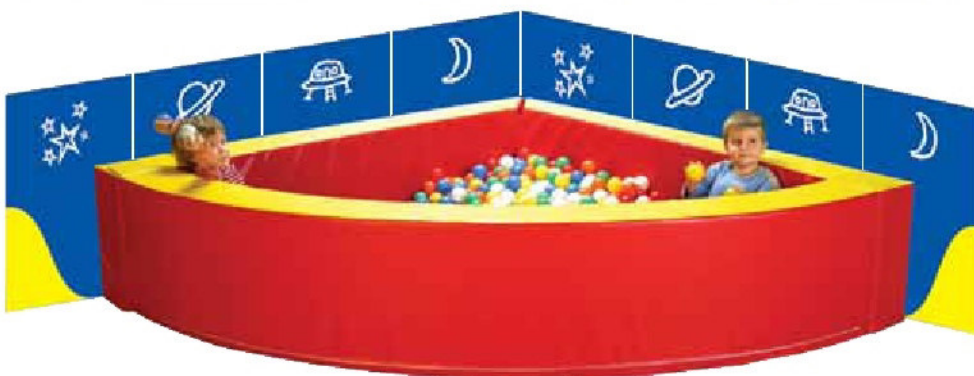

Spielen ohne Beulen und Tränen! Unsere Wandmatten können einfach und individuell mit Klettband an der Wand befestigt werden.

Kern: PU (RG 25)

Bezug - oben und seitlich: Leichtplanenstoff, unten: Turnmattenstoff, Reißverschluss auf der Längsseite, mit Klett auf Rückseite, loses Klettband wird zur Wandbefestigung mitgeliefert

Abmessungen: ca. 900 x 600 x 50 mm

Playing and romping without bumps and tears.

Our mats can be fixed on the wall individually with Velcro®.

core: PU foam (volume weight 25)

cover - top and sides: light tarpaulin, bottom: textured tarpaulin, zipper at the long side, Velcro® on the back, loose Velcro® will be send with to fix the mat on the wall

measurements: around 900 x 600 x 50 mm

Art. 34-530-Farbe (colour)	ohne Motiv	without motif
Art. 34-530-ST	Sterne	stars
Art. 34-530-SA	Saturn	Saturn
Art. 34-530-UF	UFO	UFO
Art. 34-530-MO	Mond	moon
Art. 34-530-SO	Sonne	sun
Art. 34-530-FL	Flugzeug	plane
Art. 34-530-EI	Eisenbahn	train
Art. 34-530-SC	Schiff	ship
Art. 34-530-AU	Auto	car
Art. 34-530-FA	Fahrrad	bicycle

Art. 34-451	Set rot	set red
	1 Wandmatte Sterne	1 wall mat stars
	1 Wandmatte Saturn	1 wall mat Saturn
	1 Wandmatte UFO	1 wall mat UFO
	1 Wandmatte Mond	1 wall mat moon
	1 Wandmatte Sonne	1 wall mat sun
	2 Wandmatten ohne Motiv	2 wall mats without motif

Art. 34-551	Set blau	set blue
	1 Wandmatte Sterne	1 wall mat stars
	1 Wandmatte Saturn	1 wall mat Saturn
	1 Wandmatte UFO	1 wall mat UFO
	1 Wandmatte Mond	1 wall mat moon
	1 Wandmatte Sonne	1 wall mat sun
	2 Wandmatten ohne Motiv	2 wall mats without motif

# Möbel

furniture

- 90 Sessel & Sofas
- 99 Matten & Polster
- 103 Wickelauflage
- 104 Kissen & Sitzsäcke

chairs and sofas  
mats and cushions  
changing mat  
pillows and beanbags



Möbel in jeder Form und Farbe. So bleibt kaum ein Wunsch offen um das Kinderzimmer, Kindergarten- oder Kinderhorträume zu möblieren. Unsere Möbel wurden nach vielen Beratungsgesprächen mit Pädagogen aus dem Fachbereich entwickelt und verbessert.

Viele Bezüge sind abnehmbar und bei 30°C waschbar (bitte nicht schleudern oder im Trockner trocknen).

Furniture in all shapes and colours. There won't be any wish left to furnish a children's room, kindergartens or day nursery rooms. Our furniture is developed and improved after a lot of consultations with educators from this department.

Many covers are removable and washable with 30°C (please do not spin or dry them in a dryer).

# Unsere Stoffbibliothek

our fabric library

Wir haben viele verschiedene Stoffe und Stoffmuster für Sie zur Auswahl. Bitte beachten Sie, dass Stoffe immer nur innerhalb ihrer Stoffgruppe kombinierbar sind. Bitte geben Sie immer die Stoffgruppe und die Stoffnummer an, Bsp.: Art. 00-0000-B12 für Stoffgruppe B und Stoffnummer 12. Stoffe aus unserem alten Katalog sind z.T. noch verfügbar. Bitte fragen Sie unser Verkaufsteam.

We have many different fabrics and fabric patterns for you to choose from. Please keep in mind that only the fabrics in one group are combinable. Please attach the fabric group and the fabric number to your order, e.g. item nr. 00-0000-B12 for fabric group B, fabric colour with nr. 12. The fabrics of our old catalogue may be still available. Please do not hesitate to ask our sales team.

Stoffgruppe (SG) A

fabric group (SG) A

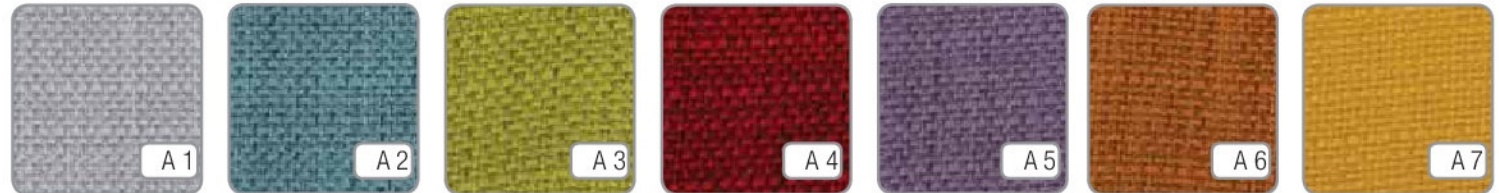

Eigenschaften: 100 % PES, fasertiefe Fleckabweisung, langlebig, schadstofffrei  
features: 100 % PES, fibre deep repelling, durable, pollution-free

Stoffgruppe (SG) B

fabric group (SG) B

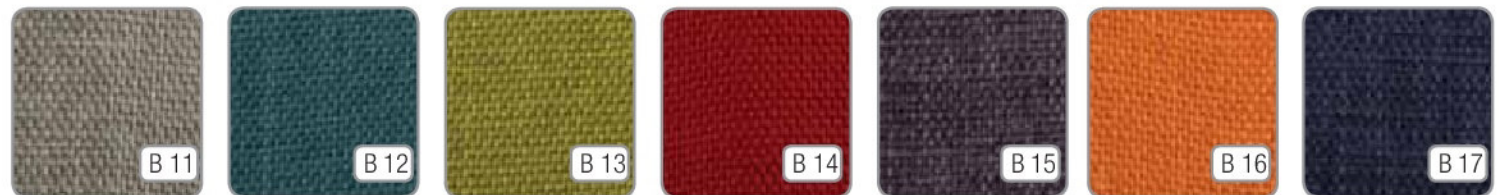

Eigenschaften: 100 % PES, Zigarettentest bestanden (BS 5852-0), 390 g/lfm, scheuerbeständig  
features: 100 % PES, cigarette test passed (BS 5852-0), 390 g/rm, scrubbable

Stoffgruppe (SG) C

fabric group (SG) C



Eigenschaften: 5 % Nylon, 95 % PES, Zigarettentest bestanden (BS 5852 Part 1), 370 g/lfm, scheuerbeständig  
features: 5 % nylon, 95 % PES, cigarette test passed, 390 g/rm, scrubbable

Stoffgruppe (SG) D

fabric group (SG) D



D 31



D 32

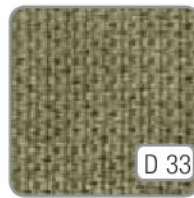

D 33



D 34



D 35



D 36



D 37



D 38

Eigenschaften: 100 % PES, ca. 390 g/m<sup>2</sup>, bei 30° C waschbar  
features: 100 % PES, approx. 390 g/m<sup>2</sup>, washable up to 30° C

Stoffgruppe (SG) E  
Kunstleder

fabric group (SG) E  
artificial leather



E 41



E 42



E 43



E 44



E 45

Eigenschaften: Brennverhalten entspricht DIN EN 1021-1, Zigarettestest bestanden, phthalatfrei, 3 % PU, 81 % PVC, 16 % PES, 500g/m<sup>2</sup>  
features: flammability in accordance to DIN EN 1021-1, cigarette test passed, phthalates-free, 3 % PU, 81 % PVC, 16 % PES, 500g/m<sup>2</sup>

Stoffgruppe (SG) F

fabric group (SG) F



F 51



F 52

Eigenschaften: 100 % PES, Microfaser, flammhemmend nach B1, kann in Verbindung mit Feuchtigkeit abfärben  
features: 100 % PES, microfibre, flame-retarding in acc. to B1, stain may stain in combination with moisture

Stoffgruppe (SG) G

fabric group (SG) G  
print 2



G 61



G 62

Eigenschaften: 100 % Baumwolle  
features: 100 % cotton

# MAXI-Sofa

MAXI sofa



Kuscheln, Ruhen oder auch Spielen wird jetzt zum Großereignis. Natürlich mit dem MAXI-Sofa.  
Cuddling, resting, or playing games is now a major event on the MAXI sofa, of course.

## MAXI-Sofa Hocker

MAXI sofa stool

**Art. 16-3070-Stoffnummer (fabric nr.)**

Der Hocker ist ideal zur Ergänzung oder als einzeln stehende Spielwiese.

Abmessungen: 1150 x 1150 x 270 mm

The stool is perfect for supplement or used as stand alone playground.

measurements: 1150 x 1150 x 270 mm



## MAXI-Sofa Eckteil

MAXI sofa corner element

**Art. 16-3071-Stoffnummer (fabric nr.)**

Das Eckteil ist eine großartige Möglichkeit große Kuschel-, Lese- und Ruheecken zu erstellen. Durch die module Bauart können alle Teile miteinander kombiniert werden.

Abmessungen: 1350 x 1350 x 570 mm

The corner element is a great way to create big cuddle, reading and rest corners. All parts can be combined by the modular construction.

measurements: 1350 x 1350 x 570 mm



## MAXI-Sofa Mittelteil

MAXI sofa middle section

**Art. 16-3072-Stoffnummer (fabric nr.)**

Das Mittelteil dient zur Verlängerung des Ecksofas.

Abmessungen: 1350 x 1350 x 570 mm

The middle section is perfect to extent the corner element.

measurements: 1350 x 1350 x 570 mm



Abbildung: Stoffnummer C24  
illustration: fabric number C24

Wir haben viele verschiedene Stoffe und Stoffmuster für Sie zur Auswahl. Schauen Sie auf Seite 88 und 89 in unsere Stoffbibliothek. Bitte beachten Sie, dass Stoffe immer nur innerhalb ihrer Stoffgruppe kombinierbar sind. Weiterhin können Microfaserstoffe in Verbindung mit Feuchtigkeit abfärben.

We have many different fabrics and fabric patterns for you to choose from. Have a look on pages 88 and 89 for our fabric library. Please keep in mind that only the fabrics in one group are combinable. In addition Microfiber fabrics may stain in combination with moisture.





## Tisch rund MINI

table round MINI

Art. 16-1040-Stoffnummer (fabric nr.)



Stoffbibliothek S. 88 - 89  
fabric library p. 88 - 89

Abmessungen: Ø 700 x 270 mm  
measurements: Ø 700 x 270 mm



Abbildung: Art. 16-1040-B14  
illustration: item nr. 16-1040-B14

## Tisch rund MAXI

table round MAXI

Art. 16-1050-Stoffnummer (fabric nr.)

Abmessungen: Ø 700 x 400 mm  
measurements: Ø 700 x 400 mm

## Tisch rechteckig MINI

table rectangular MINI

Art. 16-1060-Stoffnummer (fabric nr.)



Stoffbibliothek S. 88 - 89  
fabric library p. 88 - 89

Abmessungen: 800 x 400 x 270 mm  
measurements: 800 x 400 x 270 mm



Abbildung: Art. 16-1070-B17  
illustration: item nr. 16-1070-B17

## Tisch rechteckig MAXI

table rectangular MAXI

Art. 16-1070-Stoffnummer (fabric nr.)

Abmessungen: 800 x 400 x 400 mm  
measurements: 800 x 400 x 400 mm

## Kinder-Sessel MINI

kids chair MINI

Art. 16-3000-Stoffnummer (fabric nr.)



Stoffbibliothek S. 88 - 89  
fabric library p. 88 - 89

Abmessungen: 800 x 500 x 600 mm, Sitzhöhe: 270 mm  
measurements: 800 x 500 x 600 mm, seat height: 270 mm



Abbildung: Art. 16-3000-A2+7  
illustration: item nr. 16-3000-A2+7

## Kinder-Sessel MAXI

kids chair MAXI

Art. 16-3010-Stoffnummer (fabric nr.)

Abmessungen: 850 x 600 x 600 mm, Sitzhöhe: 370 mm  
measurements: 850 x 600 x 600 mm, seat height: 370 mm

## Eckcouch MAXI 3-teilig (linke Seite länger)

corner couch MAXI 3 pieces (left side longer)

### Art. 16-1030-Stoffnummer (fabric nr.)



Stoffbibliothek S. 88 - 89

fabric library p. 88 - 89

Klettverbindung der Einzelteile

Abmessungen: 2050 x 1550 mm, Sitzhöhe: 370 mm

Velcro® connection of the single elements

measurements: 2050 x 1550 mm, seat height: 370 mm

## Eckcouch MAXI 3-teilig (rechte Seite länger)

corner couch MAXI 3 pieces (right side longer)

### Art. 16-1020-Stoffnummer (fabric nr.)

Klettverbindung der Einzelteile

Abmessungen: 1550 x 2050 mm, Sitzhöhe: 370 mm

Velcro® connection of the single elements

measurements: 1550 x 2050 mm, seat height: 370 mm



Abbildung: Art. 16-1030-D35-36

illustration: item nr. 16-1030-D35+36

## Eckcouch MINI 3-teilig (linke Seite länger)

corner couch MINI 3 pieces (left side longer)

Art. 16-1010-Stoffnummer (fabric nr.)



Stoffbibliothek S. 88 - 89

fabric library p. 88 - 89

Klettverbindung der Einzelteile

Abmessungen: 1800 x 1400 mm, Sitzhöhe: 270 mm

Velcro® connection of the single elements

measurements: 1800 x 1400 mm, seat height: 270 mm

## Eckcouch MINI 3-teilig (rechte Seite länger)

corner couch MINI 3 pieces (right side longer)

Art. 16-1000-Stoffnummer (fabric nr.)

Klettverbindung der Einzelteile

Abmessungen: 1400 x 1800 mm, Sitzhöhe: 270 mm

Velcro® connection of the single elements

measurements: 1400 x 1800 mm, seat height: 270 mm



Abbildung: Art. 16-1010-A5+7  
illustration: item nr. 16-1010-A5+7

# Eckcouch Einzelteile

corner couch components



Stoffbibliothek S. 88 - 89

fabric library p. 88 - 89



Alle Möbel auf diesen beiden Seiten sind mit Klettverbindungen ausgestattet.  
So lassen sich große und auch kleine Sitzkombinationen erstellen.

All furniture on these two pages have Velcro® connection.  
In this way smaller or bigger sitting combinations are constructable.



## MINI

Art. 16-2030-Stoffnummer Eckcouch Sofa MINI (Armteil links)  
corner couch MINI (armrest left side)  
970 x 500 x 560 mm,  
Sitzhöhe (seat height): 270 mm



Art. 16-2040-Stoffnummer Eckcouch Sofa MINI (Armteil rechts)  
corner couch MINI (armrest right side)  
970 x 500 x 560 mm,  
Sitzhöhe (seat height): 270 mm



Art. 16-2020-Stoffnummer Eckcouch Rundteil MINI  
corner couch round part MINI  
830 x 500 x 830 mm,  
Sitzhöhe (seat height): 270 mm



Art. 16-2000-Stoffnummer Eckcouch Sessel MINI (Armteil links)  
corner couch chair MINI (armrest left side)  
570 x 500 x 560 mm,  
Sitzhöhe (seat height): 270 mm



Art. 16-2010-Stoffnummer Eckcouch Sessel MINI (Armteil rechts)  
corner couch chair MINI (armrest right side)  
570 x 500 x 560 mm,  
Sitzhöhe (seat height): 270 mm

## MAXI - ohne Abbildung (without illustration)

Art. 16-2080-Stoffnummer Eckcouch Sofa MAXI (Armteil links)  
corner couch MAXI (armrest left side)  
1230 x 630 x 560 mm,  
Sitzhöhe (seat height): 370 mm

Art. 16-2090-Stoffnummer Eckcouch Sofa MAXI (Armteil rechts)  
corner couch MAXI (armrest right side)  
1230 x 630 x 560 mm,  
Sitzhöhe (seat height): 370 mm

Art. 16-2070-Stoffnummer Eckcouch Rundteil MAXI  
corner couch round part MAXI  
830 x 630 x 830 mm,  
Sitzhöhe (seat height): 370 mm

Art. 16-2050-Stoffnummer Eckcouch Sessel MAXI (Armteil links)  
corner couch chair MAXI (armrest left side)  
730 x 630 x 560 mm,  
Sitzhöhe (seat height): 370 mm

Art. 16-2060-Stoffnummer Eckcouch Sessel MAXI (Armteil rechts)  
corner couch chair MAXI (armrest right side)  
730 x 630 x 560 mm,  
Sitzhöhe (seat height): 370 mm

## Zweisitzer-Sofa MINI

two seat sofa MINI

Art. 16-3020-Stoffnummer (fabric nr.)



Stoffbibliothek S. 88 - 89  
fabric library p. 88 - 89

Abmessungen: 1200 x 600 x 500 mm, Sitzhöhe: 270 mm  
measurements: 1200 x 600 x 500 mm, seat height: 270 mm



Abbildung: Art. 16-3030-C23+26  
illustration: item nr. 16-3030-C23+26

## Zweisitzer-Sofa MAXI

two seat sofa MAXI

Art. 16-3030-Stoffnummer (fabric nr.)

Abmessungen: 1400 x 600 x 600 mm, Sitzhöhe: 370 mm  
measurements: 1400 x 600 x 600 mm, seat height: 370 mm

## Dreisitzer-Sofa MINI

three seat sofa MINI

Art. 16-3040-Stoffnummer (fabric nr.)



Stoffbibliothek S. 88 - 89  
fabric library p. 88 - 89

Abmessungen: 1600 x 600 x 500 mm, Sitzhöhe: 270 mm  
measurements: 1600 x 600 x 500 mm, seat height: 270 mm



Abbildung: Art. 16-3050-D35+36  
illustration: item nr. 16-3050-D35+36

## Dreisitzer-Sofa MAXI

three seat sofa MAXI

Art. 16-3050-Stoffnummer (fabric nr.)

Abmessungen: 1900 x 600 x 600 mm, Sitzhöhe: 370 mm  
measurements: 1900 x 600 x 600 mm, seat height: 370 mm

## Klappsessel MINI

folding chair MINI

Art. 16-4020-Stoffnummer (fabric nr.)



Stoffbibliothek S. 88 - 89  
fabric library p. 88 - 89



Abmessungen zusammengeklappt: 400 x 500 mm, Sitzhöhe: 220 mm  
Abmessungen aufgeklappt: 400 x 1200 mm, Sitzhöhe: 110 mm  
measurements folded: 400 x 500 mm, seat height: 220 mm  
measurements opened: 400 x 1200 mm, seat height: 110 mm

Abbildung: Art. 16-4020-C26+27  
illustration: item nr. 16-4020-C26+27

## Klappsessel MAXI

folding chair MAXI

Art. 16-4030-Stoffnummer (fabric nr.)



Abmessungen zusammengeklappt: 650 x 650 mm, Sitzhöhe: 340 mm  
Abmessungen aufgeklappt: 650 x 1550 mm, Sitzhöhe: 170 mm  
measurements folded: 650 x 650 mm, seat height: 340 mm  
measurements opened: 650 x 1550 mm, seat height: 170 mm

## Klappsofa MINI

folding sofa MINI

Art. 16-4040-Stoffnummer (fabric nr.)



Stoffbibliothek S. 88 - 89  
fabric library p. 88 - 89



Abmessungen zusammengeklappt: 800 x 600 mm, Sitzhöhe: 220 mm  
Abmessungen aufgeklappt: 800 x 1200 mm, Sitzhöhe: ca. 110 mm  
measurements folded: 800 x 600 mm, seat height: 220 mm  
measurements opened: 800 x 1200 mm, seat height: 110 mm

Abbildung: Art. 16-4010-E41+44  
illustration: item nr. 16-4010-E41+44

## Klappsofa MAXI

folding sofa MAXI

Art. 16-4010-Stoffnummer (fabric nr.)



Abmessungen zusammengeklappt: 1300 x 650 mm, Sitzhöhe: 340 mm  
Abmessungen aufgeklappt: 1300 x 1550 mm, Sitzhöhe: 170 mm  
measurements folded: 1300 x 650 mm, seat height: 340 mm  
measurements opened: 1300 x 1550 mm, seat height: 170 mm

# Kindermöbel

kids furniture

Was vorher Planenstoff war, können Sie jetzt auch beliebig in den verschiedenen Stoffgruppen kombinieren. Lassen Sie sich von den Stoffmustern verzaubern und bestellen Sie gleich ein Musterbuch unserer Stoffe.

What was before a tarpaulin material, you can combine with new materials now. Feel the fascination of new materials and enjoy the possibility of combination. Request samples of our cover materials.

## Sitzgruppe 5-teilig – seat group 5 pieces

Art. 70-3010-Stoffnummer (fabric nr.)



## Einzelteile

components



Stoffbibliothek S. 88 - 89  
fabric library p. 88 - 89

1	Art. 70-2011-Stoffnummer (fabric nr.)	Viertelkreis ohne Rücken quadrant without back	455 x 455 x 250 mm
2	Art. 70-2016-Stoffnummer (fabric nr.)	Ecksitz Mitte corner seat middle	660 x 455 x 500 mm
3	Art. 70-2018-Stoffnummer (fabric nr.)	Ecksitz links corner seat left side	515 x 455 x 500 mm
4	Art. 70-2019-Stoffnummer (fabric nr.)	Ecksitz rechts corner seat right side	515 x 455 x 500 mm
5	Art. 70-2013-Stoffnummer (fabric nr.)	Eckteil corner element	760 x 760 x 250 mm
6	Art. 70-2017-Stoffnummer (fabric nr.)	Sitz, lang long seat	610 x 455 x 500 mm
7	Art. 70-2015-Stoffnummer (fabric nr.)	Sitz, kurz short seat	380 x 455 x 500 mm
8	Art. 70-2014-Stoffnummer (fabric nr.)	Quadrat ohne Rücken square without back	455 x 455 x 250 mm

## Klapp-Polster Wolke

folding cushion cloud

Art. 16-5001 (hellblau/orange, light blue/orange)

Art. 16-5000 (rot/blau, red/blue)



Ein idealer Platz zum Spielen, Toben - Ausruhen und Träumen. Mit dieser klappbaren Wolke schweben die Kinder im siebten Himmel. Denn der weiche Kern lädt zum Schmusen und Schlummern ein. Ein idealer Ruheort für Kuschelecken in Kindergärten und privaten Haushalten.

Bezug: Art. 16-5001: Microfaser hellblau/orange, Reißverschluss

Art. 16-5000: Baumwollstoff rot/blau, Reißverschluss

Kern: fester Schaumstoffkern

zusammengeklappt: 2000 x 600 x 300 mm

aufgeklappt: 2000 x 1200 x 150 mm

The ideal place for relaxing and dreaming. Children will walk on air. The soft core invites to cuddle or to lie dormant. An ideal snooze room for nursery schools and private sector.

cover: item nr. 16-5001: microfiber light blue/orange, zipper

item nr. 16-5000: cotton fabric red/blue, zipper

core: solid foam

measurements folded: 2000 x 600 x 300 mm

measurements opened: 2000 x 1200 x 150 mm

## Das kleine Glück

the little happiness

Art. 16-7000



Auf dem kleinen Glückskleeblatt gibt es Platz zum Ausruhen oder Lesen.

Und wer ganz fest daran glaubt, bekommt noch etwas Glück dazu.

Bezug: allseitig Baumwollstoff grün

Kern: fester Schaumstoffkern

zusammengeklappt: 2000 x 600 x 300 mm

aufgeklappt: 2000 x 1200 x 150 mm

On the small four-leafed clover there is room for resting or reading. Who firmly believes, get a bit of luck in addition.

cover: all-round cotton green

core: solid foam

measurements folded: 2000 x 600 x 300 mm

measurements opened: 2000 x 1200 x 150 mm



## Eckcouch Viertelkreis 4-teilig

corner sofa quadrant 4 pieces

Art. 16-1110



- 1 Viertelkreis 1: 1430 x 1430 x 200 mm  
quadrant 1
- 2 Viertelkreis 2: 650 x 650 x 200 mm  
quadrant 2
- 3 Rückenpolster (2 Stk.): 1430 x 200 x 200 mm  
backrest cushion

Bezug: Leichtplanenstoff  
cover: light tarpaulin

## Kuschelmatratze

cuddle mattress



Abbildung: Art. 16-5040-F51  
illustration: item nr. 16-5040-F51



Stoffbibliothek S. 88 - 89  
fabric library p. 88 - 89

Art. 16-5040-Stoffnummer (fabric nr.)

1600 x 1600 x 200 mm

Art. 16-5045-Stoffnummer (fabric nr.)

1200 x 1200 x 200 mm

Rückenpolster sind optional erhältlich. The backrest cushions are optional available.

## Viertel-Kuschelmatratze

quarter cuddle mattress



Abbildung: Art. 16-5050-C22+26 (ohne Rückenpolster)  
illustration: item nr. 16-5050-C22+26 (without backrest cushions)



Stoffbibliothek S. 88 - 89  
fabric library p. 88 - 89

Art. 16-5050-Stoffnummer (fabric nr.)

Abmessungen: 1600 x 1600 x 200 mm

Rückenpolster sind optional erhältlich. The backrest cushions are optional available.

## Spiel- und Schlafcke

floor play and sleep mattress



Abbildung: Art. 16-5061-C24+25 (ohne Rückenpolster)  
illustration: item nr. 16-5061-C24+25 (without backrest cushions)



Stoffbibliothek S. 88 - 89  
fabric library p. 88 - 89

Art. 16-5061-Stoffnummer (fabric nr.)	1600 x 1600 x 80 mm
Art. 16-5062-Stoffnummer (fabric nr.)	1800 x 1800 x 80 mm
Art. 16-5063-Stoffnummer (fabric nr.)	2000 x 2000 x 80 mm

Rückenpolster sind optional erhältlich. The backrest cushions are optional available.

## Spiel- und Schlafcke klappbar

foldable floor play and sleep mattress



Abbildung: Art. 16-5090-C23+27 (ohne Rückenpolster)  
illustration: item nr. 16-5090-C23+27 (without backrest cushions)



Stoffbibliothek S. 88 - 89  
fabric library p. 88 - 89

Art. 16-5070-Stoffnummer (fabric nr.)	2000 x 2000 x 80 mm
Art. 16-5080-Stoffnummer (fabric nr.)	1800 x 1800 x 80 mm
Art. 16-5090-Stoffnummer (fabric nr.)	1600 x 1600 x 80 mm

Rückenpolster sind optional erhältlich. The backrest cushions are optional available.

## Rückenpolster

backrest cushion



Abbildung: Art. 16-5095-C22  
illustration: item nr. 16-5095-C22



Stoffbibliothek S. 88 - 89  
fabric library p. 88 - 89

Art. 16-5075-Stoffnummer (fabric nr.)	2000 mm
Art. 16-5085-Stoffnummer (fabric nr.)	1800 mm
Art. 16-5095-Stoffnummer (fabric nr.)	1600 mm
Art. 16-5046-Stoffnummer (fabric nr.)	1200 mm

## Bodenliegepolster

floor cushion



Das Bodenliegepolster ist für den Einsatz als Ruhe- und Schlafmatratze konzipiert worden. Die Hülle besteht aus zwei verschiedenen Materialien. Das rote Kunstleder ist ideal für Sommermonate und ist außerdem urin- und speichelresistent. Die blaue Seite besteht aus Baumwolle und kann gut in den Wintermonaten benutzt werden.

The floor cushion has been designed for use as a rest and sleep mattress. The cover is made of two different materials. The red artificial leather is perfect for summer months, urine and saliva-resistant in addition. The blue side is made of cotton and perfect for winter months.

Art. 97-060E	1325 x 550 x 80 mm
Art. 97-061E	1400 x 600 x 80 mm
Art. 97-067E	1600 x 540 x 80 mm
Art. 97-068E	1600 x 600 x 80 mm



## Bodenliegepolster

floor cushion



Das Bodenliegepolster ist für den Einsatz als Ruhe- und Schlafmatratze konzipiert worden. Die Hülle besteht aus zwei verschiedenen Materialien. Das rote Kunstleder ist ideal für Sommermonate und ist außerdem urin- und speichelresistent.

The floor cushion has been designed for use as a rest and sleep mattress. The cover is made of two different materials. The red artificial leather is perfect for summer months, urine and saliva-resistant in addition.

Art. 97-060K	1325 x 550 x 80 mm
Art. 97-061K	1400 x 600 x 80 mm
Art. 97-067K	1600 x 540 x 80 mm
Art. 97-068K	1600 x 600 x 80 mm



# Wickelauflage

changing mat

Kunstleder ist in diesen Farben erhältlich:

synthetic leather is available with these colours:

GR HB BL RO OR GE

Leichtplanenstoff ist in diesen Farben erhältlich:

light tarpaulin is available with these colours:

HG GR HB BL RO OR GE

Planenstoff ist in diesen Farben erhältlich:

tarpaulin is available with these colours:

GR BL RO GE GU



1



2



3

Unsere Wickelauflagen werden individuell nach Ihren Vorstellungen gefertigt. Wir passen Sie auf Ihre Bedürfnisse bzw. an Ihre Möbelstücke an. Anhand Ihrer Anfrage erstellen wir Ihnen eine Zeichnung, die Ihnen die fertige Matte visualisieren soll. Das Endprodukt ist selbstverständlich wasser-, speichel- und urinfest.

Kern: fester Schaumstoff

Our changing mats are produced on your needs. Based on your request we create a drawing to visualize the finished mat. The mat is waterproof, saliva and urine resistant.

core: solid foam

## ohne Aufkantung (without upstand)

### 1 Leichtplanenstoff genäht (light tarpaulin, sewn)

Art. 08-2000	600 x 800 x 60 mm
Art. 08-2010	700 x 800 x 60 mm
Art. 08-2020	800 x 800 x 60 mm
Art. 08-2030	600 x 900 x 60 mm
Art. 08-2040	700 x 900 x 60 mm
Art. 08-2050	800 x 900 x 60 mm
Art. 08-2060	900 x 800 x 60 mm

### 1 Kunstleder genäht (artificial leather, sewn)

Art. 08-2500	600 x 800 x 60 mm
Art. 08-2510	700 x 800 x 60 mm
Art. 08-2520	800 x 800 x 60 mm
Art. 08-2530	600 x 900 x 60 mm
Art. 08-2540	700 x 900 x 60 mm
Art. 08-2550	800 x 900 x 60 mm
Art. 08-2560	900 x 800 x 60 mm

### 1 Planenstoff vollverschweißt (tarpaulin, welded)

Art. 08-3000	600 x 800 x 60 mm
Art. 08-3010	700 x 800 x 60 mm
Art. 08-3020	800 x 800 x 60 mm
Art. 08-3030	600 x 900 x 60 mm
Art. 08-3040	700 x 900 x 60 mm
Art. 08-3050	800 x 900 x 60 mm
Art. 08-3060	900 x 800 x 60 mm

## mit Aufkantung (with upstand)

### 2 Leichtplanenstoff genäht (light tarpaulin, sewn)

Art. 08-1000	600 x 800 x 200 mm
Art. 08-1010	700 x 800 x 200 mm
Art. 08-1020	800 x 800 x 200 mm
Art. 08-1030	600 x 900 x 200 mm
Art. 08-1040	700 x 900 x 200 mm
Art. 08-1050	800 x 900 x 200 mm
Art. 08-1060	900 x 800 x 200 mm

### 2 Kunstleder genäht (artificial leather, sewn)

Art. 08-1500	600 x 800 x 200 mm
Art. 08-1510	700 x 800 x 200 mm
Art. 08-1520	800 x 800 x 200 mm
Art. 08-1530	600 x 900 x 200 mm
Art. 08-1540	700 x 900 x 200 mm
Art. 08-1550	800 x 900 x 200 mm
Art. 08-1560	900 x 800 x 200 mm

### 3 Planenstoff vollverschweißt (tarpaulin, welded)

Art. 08-3500	600 x 800 x 200 mm
Art. 08-3510	700 x 800 x 200 mm
Art. 08-3520	800 x 800 x 200 mm
Art. 08-3530	600 x 900 x 200 mm
Art. 08-3540	700 x 900 x 200 mm
Art. 08-3550	800 x 900 x 200 mm
Art. 08-3560	900 x 800 x 200 mm

## Riesen-Kuschelkissen

giant cuddle pillow

Art. 16-5030



Das Riesen-Kuschelkissen ist der richtige Platz um sich einzukuscheln, auszuruhen oder auszutoben. Der Bezug ist durch einen Reißverschluss leicht wechsel- und waschbar.

Bezug: Nylon, Abmessungen: 2000 x 2000 x 300 mm

The giant cuddle pillow provides ideal conditions for cuddling, relaxing and letting of steam. The cover is easy to remove and to wash, because of the zipper.

cover: nylon, measurements: 2000 x 2000 x 300 mm

## Polstermatte Rundkissen

round pillow cushion

Art. 34-2000Ny



Hier liest und relaxt man am Liebsten. Wahrscheinlich gilt das Rundkissen nicht grundlos als Lieblingsplatz in Kindergärten.

Das Kissen ist gefüllt mit Styroporkügelchen. So lässt sich die richtige Wohlfühlposition sehr schnell finden.

Bezug: Nylon, Abmessungen: Ø 1000 x 300 mm

A place to read or relax. The round pillow cushion is probably not without reason a favorite place in kindergartens. It is filled with styrofoam pellets. Hereby you will find the most comfortable position very quickly.

cover: nylon, measurements: Ø 1000 x 300 mm

## Polstermatte Riesenkissen

giant pillow cushion

Art. 34-2010Ny



Das sehr strapazierfähige Riesenkissen lädt alle Kinder ein auf ihm herumzutoben. Aber auch als Kuschelkissen ist das Riesenkissen super geeignet.

Bezug: Nylon, Abmessungen: 2000 x 2000 x 200 mm

Our durable giant pillow cushion invites all children to romp on it. But it is also super suitable as cuddly pillow. cover: nylon, measurements: 2000 x 2000 x 200 mm

## Knautschinsel Nylon

crumple island nylon



Die Knautschinsel ist ein toller Platz zum Ruhen aber auch zum Herumtollen. Durch die Styroporkugelfüllung bekommt man einen tollen Sitz auf der Insel.

The crumple island made of nylon is a great place to rest and frolic. Through the styrofoam pellets filling you get a great seat on it.

Art. 16-5020                      Ø 700 mm

Art. 16-5010                      Ø 1000 mm

Kissen weiß (crumple island white):

Art. 96-078                      Ø 1000 mm

## Sitzsäcke Nylon

beanbag nylon



Ein bequemer Sitzsack in zwei verschiedenen Größen. Durch die Tragelast ist ein einfacher Transport garantiert. Natürlich lassen sich die Säcke auch ohne Probleme an der Tragevorrichtung aufhängen.  
So entsteht wieder schnell Platz zum Spielen.

A very comfortable beanbag in two different sizes. The transport is guaranteed by the carry handle. Of course you can hang up the beanbag with the help of carrying handle, thereby one has place to play again.

Art. 16-5100                      400 x 600 x 600 mm

Art. 16-5110                      800 x 1000 x 1000 mm

# Stichwortverzeichnis

A	 Achteckraupe	52	F	 Fallschutzmatte Turm Skandia	76	N	 Neuigkeiten: Kunstlederbausteine	18 – 19	S	 Super-Leichtturmplatte MagCon	63
B	 BaBa - Ballbad	43		 Faltmatte	66	P	 Pferdeschaukel	59	T	 Timeout-Räume	84
	 BaLa - Balance Modul	42		 FSM Superleicht	73		 Pferdesattel	59		 Tisch rechteckig	92
	 Balancierbalkenwürfel	52	G	 Geo-Max	55		 Polstermatte Rundkissen	104		 Tisch rund	92
	 Ballbad abgedeckt	50		 Gerättummatte Standard	63		 Polstermatte Riesenkissen	104		 Trapezelement	52
	 Bälle	48		 Gerättummatte Leicht Exklusiv	64		 Prallschutz für Außenbereiche	82		 Treppenrutsche groß	49
	 Bänfers Hüppeding	51		 Gerättummatte WEBO	64		 Prallschutz für Doppel-T-Träger	81		 Treppenrutsche klein	49
	 Baumodule	21 – 45	H	 Haus-Puzzle	56		 Prallschutz für Ecken	81		 Treppenwippe	54
	 Baumodule MAXI	26 – 31		 HaZy - Halbzylinder-Balance	42		 Prallschutz für Säulen, quadrat.	81		 Tunnel Long	56
	 Baumodule MEDI	22 – 25		 Hüpfekästchen	61		 Prallschutz Fensterbank	82		 TuReSi - Tunnel-Regal-Sitz Modul	43
	 Bausteinsätze	7 – 19	I	 Individuallösungen	4, 77, 78		 Prallschutz Heizkörper	82		 Turnbankschutzpolster	68
	 Bausteinsätze MAXI	12 – 17		 Individuelle Fallschutzlösungen	78		 Projektarbeit	45, 83		 Turnen, Fall- & Prallschutz	62 – 86
	 Bausteinsätze MEDI	10 – 11	K	 Karlichen das Krokodil	57	R	 Regenbogen-Ballbad	49	V	 Varianten der Fallschutzsysteme	79
	 Bausteinsätze MINI	8 – 9		 Kinder-Klappsessel	55		 Riesen-Kuschelkissen	104		 Vario-Step	67
	 Bewegungsbaustelle - BeMo	40 – 44		 Kindermöbel	98		 Riesenmatte	50		 Vario-Top	67
	 BIG Rutsche	48		 Klapp-Polster Wolke	99		 Rollbretter	54		 Viereck-Ballbad	49
	 Bodenliegepolster	102		 Kinder-Sessel	92		 Rückenpolster	101		 Viereck-Schaukel	59
	 Bodenturnmatte	68		 Klappsessel	97		 Rundschaukel	58		 Viertelkreis-Ballbad groß	47
D	 Das kleine Glück	99		 Klappsofa	97	S	 Säulenschutzpolster, rund	80		 Viertelkreis-Ballbad klein	47
	 Dreisitzer-Sofa	96		 Knautschinsel Nylon	105		 Schutzpolster	80		 Viertel-Kuschelmatratze	100
E	 Eckcouch 3-teilig	93 – 94		 Krabbelwalze	54		 Schutzpolster für Kletteranlagen	82	W	 Wandmatten	86
	 Eckcouch Einzelteile	95		 Kreativ-Spiel	46 – 61		 Schutzpolster für Sprossenwand	83		 Weichböden mit Bausteinkern	16 – 17
	 Eckcouch Viertelkreis 4-teilig	100		 Kuschelmatratze	100		 SiTi - Sitz-Tisch Modul	42		 Weichboden Standard	70
	 Einzelteile MAXI	34 – 39	L	 Leichtturmplatte	65		 Sitzgruppe 5-teilig	98		 Weichboden WEBO	71
	 Einzelteile MEDI	32 – 33		 LuKi - Airtrack	43		 Sitzsäcke Nylon	105		 Weitsprungmatte	61
	 Elfi die Ente	57	M	 Mattenwagen Standard	69		 Sitzschaukel	58		 Wickelaufgabe	103
F	 Fall- & Prallschutz	62 – 86		 Mattengurte	69		 Snoezelenräume	85		 Wut-Keule	51
	 Fallschutzmatte FSM 160/60 (LP)	73		 MAXI-Sofa	90 – 91		 Spiel- und Schlafcke	101	Z	 Zusatzmdule BeMo	44
	 Fallschutzmatte FSM 160/60 (V.)	74		 Möbel	87 – 105		 Spiel- und Schlafcke klappbar	101		 Zweisitzer-Sofa	96
	 Fallschutzmatte Light	74		 Motorik-Ball	53		 Spielmatten mit Kindermotiven	60			
	 Fallschutzmatte Skandia 100	75					 Spielröhre mit Innenzylinder	53			
	 Fallschutzmatte Skandia 150	75					 Spieltonne	53			
	 Fallschutzmatte Sofa Skandia	76					 Stoffbibliothek	88 – 89			
							 Super-Leichtturmplatte	65			

# Index

A	additional modules BeMo	44	F	floor cushion	102	M	mat belts	69	S	safety mat Skandia 100	75	
	anger club	51		floor exercise mat	68		MAXI sofa	90 – 91		safety mat Skandia 150	75	
	apparatus exercise mat standard	63		floor play & sleep mattress	101		module sets	7 – 19		safety mat tower Skandia	76	
	apparatus exercise mat light excl.	64		foldable floor play & sleep matt.	101		module sets MAXI	12 – 17		safety mat ultra light	73	
	apparatus exercise mat WEBO	64		folding chair	97		module sets MEDI	10 – 11		scooters	54	
B	BaBa - ball pool	43		folding cushion cloud	99		module sets MINI	8 – 9		seat group 5 pieces	98	
	backrest cushion	101		folding mat	66		motor skills ball	53		seat swing	58	
	BaLa - balance module	42		folding sofa	97		movement site - concept BeMo	40 – 44		SiTi - seat table module	42	
	balance beam cube	52		furniture	87 – 105	N	news: artificial leather module sets	18 – 19		small quarter circle ball pool	47	
	ball pool with cap	50	G	Geo-Max	55		octagonal caterpillar	52		small stairway slide	49	
	balls	48		giant cuddle pillow	104		padding for radiators & window sill	82		Snoezelen rooms	85	
	Bänfers Hüppeding	51		giant mat	50		padding for double T-girder	81		square ball pool	49	
	beanbag nylon	105		giant pillow cushion	104		padding for outdoor areas	82		stair rocker	54	
	bench padding	68		gymnastics, paddings	62 – 86	P	padding for wall bars	83		super lightweight exercise mat	65	
	big quarter circle ball pool	47		HaZy - half cylinder balance module	42		playing drum	53		super lightw. exercise mat MagCon	63	
	BIG slide	48		hopscotch	61		playing mats w. ch. motifs	60	T	table rectangular	92	
	big stairway slide	49		house puzzle	56		playing tube with interior cylinder	53		table round	92	
C	changing mat	103		horse saddle	59		project related work	45, 83		the little happiness	99	
	circular pillar protection pads	80		horse swing	59		protection pads	80		three seat sofa	96	
	components MAXI	34 – 39		I	ind. fall protection solutions	78	Q	quadratic pillar protection pads	81		timeout rooms	84
	components MEDI	32 – 33		individual manufacture	4, 77, 78		quarter cuddle mattress	100		TuReSi - tunnel shelf seat module	43	
	corner couch 3 pieces	93 – 94		K	Karl the crocodile	57	R	rainbow ball pool	49		trapeze element	52
	corner couch components	95		kids chair	92		rectangle swing	59		trolley standard	69	
	corner sofa quadrant 4 pieces	100		kids folding chair	55		round pillow cushion	104		tunnel long	56	
	crawl cylinder	54		kids furniture	98		round swing	58		two seat sofa	96	
	creative play	46 – 61		L	landing mat standard	70	S	safety mat couch Skandia	76	V	variants of the fall protection sys.	79
	crumple island nylon	105		landing mat WEBO	71		safety mat FSM 160/60 (li. tarp.)	73		vario step	67	
	cuddle mattress	100		landing mat w. module set inside	16 – 17		safety mat FSM 160/60 (vinyl)	74		vario top	67	
E	Elfi the duck	57		lightweight exercise mat	65		safety mat light	74	W	wall mats	86	
	element sets	21 – 45		long jump mat	61							
	element sets MAXI	26 – 31		LuKi - Airtrack	43							
	element sets MEDI	22 – 25										
F	fabric library	88 – 89										